

# MOTORCYCLES & PARTS 2021





 **YANNICK COQUARD**  
CO-FOUNDER & FORMER  
PROFESSIONAL RACER

**NORMANDIE, FRANCE**

**DEPUIS 2004, YCF® DÉVELOPPE ET FABRIQUE DES MOTOS POUR LE GRAND PUBLIC, LE LOISIR ET LA COMPÉTITION. CHAQUE ANNÉE UNE NOUVELLE GAMME COMPLÈTE DE MOTOS FIABLES, ACCESSIBLES ET PERFORMANTES EST PROPOSÉE AFIN DE PROFITER PLEINEMENT DES JOIES DE LA MINI MOTO EN TOUTE SÉCURITÉ.**

**100% DES PRODUITS YCF SONT CONÇUS, DÉVELOPPÉS ET DESSINÉS EN INTERNE. GRACE AU DÉVELOPPEMENT EN COMPÉTITION, LES PRODUITS YCF BÉNÉFICIENT DES DERNIÈRES ÉVOLUTIONS DISPONIBLES POUR LE GRAND PUBLIC, POUR TOUTE LA FAMILLE.**

**BON RIDE À TOUS**

**NORMANDY, FRANCE**

**YCF® HAS BEEN DEVELOPING AND MANUFACTURING MOTORCYCLES FOR THE LAST 16 YEARS. BIKES MATCHED TO SKILL LEVELS FROM BEGINNERS TO ADVANCED. WHETHER YOU'RE PLAY RIDING OR COMPETING THERE'S A BIKE FOR YOU. EACH YEAR A NEW RANGE OF RELIABLE, AFFORDABLE AND HIGH-PERFORMANCE MOTORCYCLES ARE INTRODUCED. IT ALLOWS YOU TO EXPERIENCE ALL THE FUN THAT MINI BIKES HAVE TO OFFER. 100% OF YCF PRODUCTS ARE DEvised, DESIGNED AND DEVELOPED IN-HOUSE. DUE TO BEING DEVELOPED UNDER COMPETITION CONDITIONS, YCF® TAKE'S ADVANTAGE OF THE VERY LATEST ADVANCES. THANK YOU FOR CHOOSING YCF®, HAVE A FUN RIDE!**



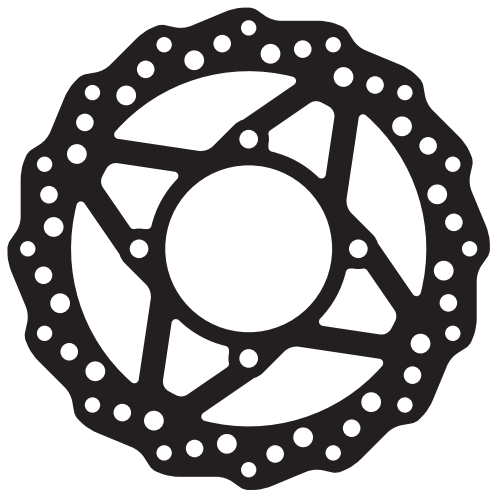

SPECIAL PARTS



FACTORY PARTS



FOR 50 ONLY



FOR SUPERMOTO



FOR BIGY® ONLY



ARRO® TIRES



DAYTONA® ENGINES



ENGI® FORK



MIKUNI® CARBURETORS



KEIHIN® CARBURETORS



TWINAIR® FILTERS



D'COR VISUALS® GRAPHICS



NIBBI CARBURETORS®



MITAS® TIRES



WILBERS SUSPENSIONS



## GAMME 2021 RANGE 2021

YCF 50A	10
YCF 50E	12
LITE F88S	16
LITE F125	18
START F88SE	20
YCF W88	22
START F125	24
START F125SE	26
PILOT F125	28
PILOT F150	30
FACTORY SP2 F150	32
FACTORY SP3 F190	34
SM F125	36
SM F155	38
SM F190	40
BIGY 125 MX	42
BIGY 150 MX	44
BIGY 190 MX FACTORY ZE	46
BIGY 190 MX FACTORY DAYTONA®	48
PADDOCK/ PADDOCK	50
TEXTILES/ APPAREL	52

## ACCESSOIRES PLASTIQUES PLASTIC PARTS

KITS DÉCO/ GRAPHIC KITS	54
PERSONNALISATION/ CUSTOMIZATION	61
KITS PLASTIQUES/ PLASTIC KITS	62

## PIÈCES MOTO CYCLE PARTS

GUIDONS/ HANDLEBARS	72
POIGNÉES/ LEVERS	74
FOURCHES/ FORKS	76
CADRES/ FRAMES	79
SELLES/ SEATS	80
RÉSERVOIRS/ FUEL TANKS	81
FREINS/ BRAKES	82
BRAS OSCILLANTS/ SWING ARMS	90
AMORTISSEURS/ SHOCK ABSORBERS	92
ROUES/ WHEELS	93
JANTES & MOYEUX/ RIMS & HUBS	93
PNEUS/ TIRES	100
REPOSE-PIEDS & SABOTS/ FOOT PEGS & SKID PLATES	102
SÉLECTEURS/ SHIFT LEVERS	103
KITS CHAÎNES/ SPROCKET KITS	104
OUTILS/ TOOLS	106
ENGI®/ ENGI®	108

## PIÈCES MOTEUR ENGINE PARTS

MOTEURS DAYTONA®/ DAYTONA® ENGINES	112
MOTEURS/ ENGINES	113
KITS MOTEUR/ ENGINE KITS	114
EMBAYAGE/ CLUTCH	116
KITS DRESS UP/ DRESS UP KITS	118
CARBURATEURS/ CARBURETORS	120
FILTRES À AIR/ AIR FILTERS	122
ÉCHAPPEMENTS/ EXHAUSTS	123
FILTRES & RADIATEURS/ FILTERS & COOLERS	126
ALLUMAGE/ IGNITION	128
PIÈCES RACING DAYTONA®/ DAYTONA® RACING PARTS	130
PIÈCES D'ORIGINE DAYTONA®/ DAYTONA® PARTS	131

# INDEX - FRENCH 2021

## A

AIGUILLE DE CARBURATEUR.....	120
ALLUMAGE.....	128/130
AMORTISSEUR.....	92/109
ANTIPARASITE.....	129
ARBRE DE BOÎTE.....	115
ARRACHE VOLANT.....	106
ATTACHE RAPIDE DE CHAÎNE.....	104
ATTACHE SILENCIEUX.....	123/124
AXE DE BRAS OSCILLANT.....	91
AXE DE ROUE.....	97
AXE DE PLAQUETTE DE FREIN.....	82

## B

BÂCHE MOTO.....	50
BAGUE D'AMORTISSEUR.....	92
BAGUE DE FOURCHE.....	76/108
BANDEROLE.....	50
BANNER.....	50
BARNUM.....	50
BARRE DE REPOSE-PIED.....	102
BATTERIE.....	128
BAVETTE D'AMORTISSEUR.....	92
BAVETTE AVEC PHARE.....	69
BÉQUILLE.....	51/79/92
BOBINE D'ALLUMAGE.....	128
BOÎTE À AIR.....	122
BONNET.....	52
BOUCHON DE RÉSERVOIR.....	81
BOUCHON DE VALVE.....	100
BOUCHON DE PURGE DE FOURCHE.....	76
BOUCHON DE VIDANGE.....	126
BOUCLE ARRIÈRE.....	79
BOUGIE.....	129
BRAS OSCILLANT.....	90
BRIDE DE POT.....	123

## C

CÂBLE DE GAZ.....	75
CÂBLE D'EMBRAYAGE.....	75
CÂBLE DE PÉDALE DE FREIN.....	86
CACHE CDI.....	119
CACHE CULASSE.....	119/130
CACHE FILTRE À HUILE.....	118/130

CACHE POUSSIÈRE.....	108
CACHE SOUPAPES/ FILTRE À HUILE.....	118/119
CADRE.....	79
CAGE DE FILTRE À AIR.....	122
CALES PIEDS.....	102
CALE PLASTIQUE DE PIPE D'ADMISSION.....	121
CALE DE PONTET DE GUIDON 20 mm.....	77
CAOUTCHOUC D'EMBRAYAGE.....	75
CAOUTCHOUC DE LEVIER DE FREIN.....	75
CAOUTCHOUC D'ÉTRIER.....	85
CAPOT DE MAÎTRE-CYLINDRE FREIN.....	89
CARBURATEUR.....	120
CARTER D'ALLUMAGE.....	114
CARTER D'EMBRAYAGE.....	117
CASQUETTE.....	52
CDI.....	128
CERCEAU DE ROUE.....	96/97
CHAÎNE.....	104
CHAÎNE DE DÉMARREUR.....	114/130
CHAÎNE DE DISTRIBUTION.....	114/130
CHAISE PLIABLE.....	50
CHAMBRE À AIR.....	14/100
CHAPE DE MAÎTRE-CYLINDRE.....	86
CHARGEUR BATTERIE.....	128
CHEMISSETTE.....	52
CLOCHE D'EMBRAYAGE.....	116
COCOTTE D'EMBRAYAGE.....	75
COLLECTEUR.....	125
COMPTEUR D'HEURES.....	129
CONTACTEUR À CLÉ.....	129
COUPE CIRCUIT.....	129
COURONNE.....	104/105
COURONNE D'EMBRAYAGE.....	116
COUVERCLE DE FILTRE À AIR.....	122
COUVERCLE DE FILTRE À HUILE.....	118
COUVRES RAYONS.....	97
COUVRE RÉSERVOIR.....	81
CULASSE.....	115
CYLINDRE.....	115

## D

DAYTONA® (PIÈCES).....	130-135
DÉRIVE CHAÎNE.....	106
DÉMONTE PNEU.....	106
DÉCO DE CADRE.....	55
DIABOLO CNC.....	90
DISQUE DE FREIN.....	88
DISQUE D'EMBRAYAGE.....	116
DONUTS.....	75
DURITE D'ESSENCE.....	81

DURITE DE FREIN.....	84/85
DURITE D'HUILE RADIATEUR.....	126

## E

ÉCHAPPEMENT.....	123-125
ÉCHAPPEMENT COMPLET.....	124
ÉCROU DE BÉQUILLE.....	79
ÉCROU DE COLONNE DE DIRECTION.....	78
EMBOU DE PÉDALE DE FREIN.....	86
EMBOU DE POT.....	123/124
EMBOU DE MAÎTRE-CYLINDRE FREIN.....	86
EMBOU PLASTIQUE DE GUIDON.....	75
EMBRAYAGE COMPLET.....	116
ENGI® (PIÈCES).....	108/109
ENTRETOISE D'AMORTISSEUR.....	92
ENTRETOISE DE ROUE.....	98
ÉPURATEUR D'HUILE.....	126
ÉTRIER DE FREIN.....	82-85

## F

FAISCEAUX ÉLECTRIQUES.....	128
FEUTRINE.....	50
FILTRE À AIR.....	122
FILTRE À HUILE.....	126
FOND DE JANTE.....	100
FOURCHE.....	76/108
FOURCHETTE DE BOÎTE.....	115
FREIN ARRIÈRE.....	82-85
FREIN AVANT.....	82-85
FREIN FILET.....	106

## G

GARDE BOUE ARRIÈRE.....	65/66
GARDE BOUE AVANT.....	62/66/68
GICLEUR.....	120
GRIPSTER.....	97
GUIDE DE CHAÎNE.....	91
GUIDON.....	73

## H

HUBLLOT À HUILE.....	126
----------------------	-----

## J

JANTES.....	96/97
JAUGE À HUILE.....	126
JEU DE CALES MOTEUR.....	106
JEU DE RAYONS.....	97
JOINT DE BOUCHON DE RÉSERVOIR.....	81
JOINT DE CARTER D'EMBRAYAGE.....	117
JOINT DE COLONNE DE DIRECTION.....	78

JOINT DE CUVE POUR CARBURATEUR .....	120
JOINT PAPIER DE PIPE D'ADMISSION .....	121
JOINT DE POT .....	123
JOINT DE QUEUE DE SOUPAPE .....	115
JOINT SPY DE FOURCHE .....	108/76
JOINT SPY DE TIGE COMMANDE D'EMBRAYAGE .....	116
JOINT SPY DE KICK .....	116
JOINT SPY DE PSB .....	116
JOINT SPY DE ROUE .....	97
JOINT SPY DE SÉLECTEUR .....	116

## K

KICK .....	103
KIT 212cc .....	130
KIT ARBRE À CAMES RACING .....	130
KIT DÉCO .....	54-59
KIT DÉCO DE CADRE .....	55
KIT DÉPART .....	108
KIT FREIN .....	82-85
KIT LAMPE .....	69
KIT PISTON .....	114/130
KIT PLASTIQUE .....	62-68
KIT RABAISSÉ .....	92
KIT RÉFECTION D'AMORTISSEUR .....	109
KIT RÉFECTION ENTRETOISE AXE AMORTISSEUR ...	109
KIT RÉFECTION DE FOURCHE .....	76
KIT RONDELLE CNC .....	69
KIT ROUE SUPERMOTARD .....	93
KIT ROULEMENT DE COLONNE DE DIRECTION .....	78
KIT STABILISATEUR .....	14
KIT SUPERMOTARD .....	103
KIT VIS .....	69/88

## L

LAINÉ DE ROCHE .....	123
LEVIER D'EMBRAYAGE .....	74/75
LEVIER DE FREIN .....	74/75/82

## M

MAÎTRE-CYLINDRE .....	82-85
MANCHON DE BOÎTE À AIR .....	122
MANCHON DE FILTRE À AIR .....	122
MANCHON DE PIPE D'ADMISSION .....	121
MOTEUR .....	112-113
MOUSSE DE GUIDON .....	72
MOYEU .....	98

## N

NUMÉROS .....	61
---------------	----

## O

ORIFLAMME .....	50
OUIE DE RADIATEUR .....	63/66
OUTILLAGE .....	106/108

## P

PARAPLUIE .....	52
PASSE DURITE DE FREIN AVANT .....	69
PATTE DE CADRE .....	79
PATTE DE FREIN CNC .....	82
PATIN DE BRAS OSCILLANT .....	91
PATIN DE CHAÎNE .....	91
PÉDALE DE FREIN .....	86
PHARE .....	69
PIÈCES D'ORIGINE DAYTONA® .....	131
PIGNON .....	115/116
PIGNON DE CLOCHE D'EMBRAYAGE .....	116
PIGNON DE SORTIE DE BOÎTE .....	104
PIPE D'ADMISSION .....	121
PISTON .....	114/130
PLANCHE DE STICKERS .....	61
PLAQUE AVANT .....	62/67
PLAQUES LATÉRALES .....	64/67
PLAQUE PHARE .....	69
PLAQUETTES DE FREIN .....	88
PLATEAU D'ALLUMAGE .....	128
PLATINE RÉGLABLE AVEC REPOSE PIED .....	102
PNEU .....	100/101
POCHETTE DE JOINTS .....	115
POIGNÉE DE GAZ .....	74
POIGNÉES CAOUTCHOUC .....	75
POIGNÉES DE PLAQUES LATÉRALE .....	64/67
POINTEAU DE CARBURATEUR .....	120
PONTET DE GUIDON .....	77
PROTECTION DE FOURCHE .....	65
PROTECTION DE PIGNON SORTIE BOÎTE .....	105
PROTECTION SM .....	103
PROTÈGE DISQUE ARRIÈRE .....	91
PROTÈGE DISQUE AVANT .....	69
PROTÈGE LEVIER .....	72
PROTÈGE MAIN .....	72
PROTÈGE MAÎTRE-CYLINDRE .....	86

## R

RAYONS .....	97
RADIATEUR D'HUILE .....	126
RÉGULATEUR DE TENSION .....	128
RELAIS DE DÉMARREUR .....	128
REPOSE PIED .....	102

RÉSERVOIR .....	81
RÉSERVOIR RÉCUPERATEUR HUILE/ ESSENCE .....	102
RESSORT D'AMORTISSEUR .....	92
RESSORT DE BÉQUILLE .....	79
RESSORT DE KICK .....	103
RESSORT DE PÉDALE DE FREIN .....	86
RESSORT DE POT .....	123/124
RESSORT POUR ÉTRIER RADIAL .....	82
ROBINET D'ESSENCE .....	81
ROUES .....	14/93-96
ROULEMENT DE COLONNE DE DIRECTION .....	78
ROULEMENT DE ROUE .....	97
ROULEMENT DE BRAS OSCILLANT .....	91
ROULETTE DE CHAÎNE .....	91
RUBALISE DE TERRAIN .....	50

## S

SABOT .....	102
SEGMENT .....	114
SÉLECTEUR .....	103
SELLE .....	80
SILENCIEUX .....	123/124
SOUPAPE .....	115
STARTER AU GUIDON .....	121
SUPPORT DE COMPTEUR D'HEURES .....	129
SURFILTRE À AIR .....	122
SWEAT .....	52

## T

TAPIS .....	51
TÉ DE FOURCHE .....	76/77
TEESHIRT .....	50
TENDEUR DE CHAÎNE .....	105
TIGE DE COMMANDE D'EMBRAYAGE .....	116
TONNELLE .....	50
TRÉPIED .....	51

## V

VALVE PRISE AIR .....	81
VILEBREQUIN .....	114
VIS DE BÉQUILLE .....	79
VIS DE COURONNE .....	105
VIS DE CUVE .....	120
VIS DE DISQUE .....	88
VIS DE RALENTI .....	120
VIS ET ÉCROU TENDEUR DE CHAÎNE .....	91
VIS DE PLAQUETTE DE FREIN .....	88
VIS DE RÉGLAGE DE LA POIGNÉE DE GAZ .....	74
VIS RENFORCÉES POUR MOTEUR .....	79
VIS DE RICHESSE .....	120
VISSERIE .....	69/79/105

# INDEX - ENGLISH 2021

## A

AIR FILTERS.....	122
AIRBOX CAPS.....	122
AIRBOX RUBBER SLEEVES.....	122
AIRBOXES.....	122
APPAREL.....	52
AXLES.....	97

## B

BANNER ROLL.....	50
BANNERS.....	50
BAR END CAPS.....	75
BAR MOUNTS.....	77
BATTERY CHARGER.....	128
BEANIE.....	52
BEARINGS.....	91/97
BIKE STANDS.....	51
BOLT KIT FOR AXLE BLOCK.....	91
BOLT KIT FOR BRAKE DISC.....	88
BOLT KITS FOR FUEL TANK.....	69
BOLT KIT FOR PLASTIC KIT.....	69
BOLT KIT FOR SEAT.....	69
BOLT KIT FOR SPROCKET.....	105
BRAKE CALIPERS.....	82-85
BRAKE CLEVIS.....	86
BRAKE DISCS.....	88
BRAKE GUARDS (FRONT).....	69
BRAKE HOSES.....	69
BRAKE LEVERS.....	74/75/83
BRAKE LEVER RUBBERS.....	75
BRAKE MASTER CYLINDERS.....	82-85
BRAKE PADS.....	88
BRAKE PEDALS.....	86
BRAKE RESERVOIR COVER.....	89
BRAKE SYSTEMS (COMPLETE).....	82-85

## C

CAMSHAFT KIT.....	130
CAPS.....	52
CARBURETOR FLOAT.....	120
CARBURETORS.....	120
CDI.....	128
CDI COVER.....	119
CHAIN GUIDES.....	91

CHAIN LINKS.....	104
CHAIN SLIDERS.....	91
CHAIN TENSIONERS.....	91/105
CHAIN TOOLS.....	106
CHAINS.....	104
CHOKE LEVER.....	121
CLUTCH ASSEMBLY.....	116
CLUTCH BRACKET.....	75
CLUTCH CABLES.....	75
CLUTCH CONTROL OIL SEAL.....	116
CLUTCH COVER.....	117
CLUTCH FOR KICKSTARTER.....	116
CLUTCH LEVER RUBBERS.....	75
CLUTCH LEVERS.....	74/75
CLUTCH SPROCKET.....	115/116
CLUTCH TOOLS.....	106
COUNTERSHAFT SPROCKET.....	104
COUNTERSHAFT SPROCKET GUARD.....	105
COVER YX/LIFAN.....	118/119
CRANKSHAFTS.....	114
CUSTOM NUMBERS.....	61
CYLINDER HEAD COVER.....	119
CYLINDERS.....	115

## D

DAYTONA ENGINE 212 KIT.....	130
DAYTONA® PARTS.....	130-135
DIGITAL TIRE PRESSURE GAUGE.....	106
DISCS.....	88
DISK GUARD.....	69/91
DUST SEALS.....	97

## E

ENGI®.....	108/109
ENGINE ADJUSTMENT GAUGES.....	106
ENGINE BASH PLATE STEEL.....	102
ENGINE KITS.....	114/130
ENGINE REINFORCED BOLT SETS.....	79
ENGINES (COMPLETE).....	112/113
EXHAUSTS.....	123/124/126
EXHAUST END.....	123/124
EXHAUST PIPE.....	123/124
EXHAUST SEWER.....	126
EXHAUST SPRING.....	123/124
EXHAUST VALVE.....	115

## F

FENDER.....	62/65/66/68
FILTER.....	122
FLAGS (PROMOTIONAL).....	50

FLYWHEEL REMOVER.....	106
FOAM AIR FILTER.....	122
FOLDABLE LEVERS.....	74
FOLDING CHAIR.....	50
FOOT PEG MOUNT BAR.....	102
FOOT PEGS.....	102
FORK AIR BLEEDER.....	76
FORK BUSHINGS ENGI®.....	108
FORK DRAIN PLUGS.....	126
FORK GUARDS.....	65
FORK OIL SEALS.....	76/108
FORK SEAL REPAIR KIT.....	76/108
FORKS.....	76/108
FORK TOOL.....	108
FRAMES.....	79
FUEL CAPS.....	81
FUEL HOSES.....	81
FUEL TANKS.....	81
FUEL TAPS.....	81
FUEL VENT PIPES.....	81

## G

GASKET SETS.....	115/121
GEARBOX FORK (REINFORCED).....	115
GEARBOX SHAFT.....	115
GEARBOX SHAFT (COMPLETE MAIN).....	115
GEARBOX SHAFT (COMPLETE SECONDARY).....	115
GRAPHIC KITS.....	54-59
GRAPHICS FOR FRAME.....	55
GRIPS.....	75
GRIP DONUTS.....	75

## H

HANDGUARDS.....	72
HANDLEBAR PADS.....	72
HANDLEBARS.....	73
HATS.....	52
HEAD LIGHTS.....	69
HEIGHT ADJUSTMENT KIT.....	92
HIGH TENSION IGNITION COIL.....	128
HOLESHOT DEVICE.....	108
HOODIE.....	52
HOUR METER.....	129
HUB SPACERS.....	98
HUBS.....	98

## I

IDLE SCREW + SPRING.....	120
IGNITION COVER.....	114
IGNITION SWITCH.....	128



INLET PIPE .....	121
INLET VALVE.....	115
INTAKE GASKET.....	121
INTAKE MANIFOLD .....	121

## K

KICKSTAND (ADJUSTABLE).....	79
KICKSTAND SPRING .....	79
KICKSTARTER LEVER OIL SEAL .....	116
KICKSTARTER LEVERS .....	103
KICKSTARTER SPROCKET .....	116
KILL SWITCH.....	128

## L

LIGHT.....	69
LIGHTED OIL PURIFIER .....	126
LEVER PROTECTION .....	72
LAUNCH CONTROL.....	108

## M

MAGNETIC DRAIN PLUG .....	126
MAGNETO .....	128
MAIN JET .....	120
MOTORCYCLE COVER .....	50
MUD FLAP .....	92
MUDGUARDS.....	14/62/65/66/68
MUFFLER .....	123
MUFFLER CLAMPS .....	123/124
MUFFLER SPARK ARRESTOR.....	123

## N

NEEDLE VALVE + SPRING .....	120
NIPPLE WRENCH .....	106
NUMBER PLATES.....	62/64/67
NUMBERS (CUSTOM).....	61
NUT FOR STEERING STEM.....	78

## O

OIL COOLER .....	126
OIL DIPSTICK .....	126
OIL DRAIN PLUG .....	126
OIL FILTER .....	126
OIL FILTER COVER.....	118
OIL LEVEL SIGHT GLASS.....	126
OIL SEAL .....	97
OIL SEAL ASSEMBLY TOOLS.....	108
OIL SEAL FOR COUNTERSHAFT SPROCKET .....	116
OIL STEEL LINE RETAINER .....	69
OVAL MUFFLER CLAMP .....	123

## P

PISTON KITS .....	114/130
PISTON RING SETS.....	114
PIT TENT (3X3M).....	50
PLASTIC KITS.....	62-68
PUSH ROD.....	116

## R

REAR BRAKE LEVER TIPS.....	86
REAR SPOOL.....	90
REGULATOR.....	128
REMOTE SWITCH.....	129
RIM LOCKS.....	97
RIMS.....	96/97
RUBBER MANIFOLD SET .....	121
RUBBER MAT.....	51

## S

SEAL FOR FUEL TANK CAP.....	81
SEAL FOR STEERING STEM.....	78
SEATS .....	80
SHAFT .....	115
SHIFT LEVERS.....	103
SHIRTS .....	52
SHOCK ABSORBERS.....	92/109
SHOCK ABSORBERS REPAIR KIT.....	109
SHOCK ABSORBERS SPACER KIT .....	109
SHOCK ABSORBERS SPRING .....	92
SIDE PLATES.....	64/67
SKID PLATE .....	102
SLEEVE FOR CARBURETOR .....	121
SLOW JET.....	120
SPACERS .....	92/98
SPACERS FOR BAR MOUNT .....	77
SPARK ARRESTOR .....	123
SPARK PLUG REMOVAL TOOL .....	106
SPARK PLUGS .....	129
SPOKE SKINS.....	97
SPOKE TOOL.....	106
SPOKES .....	97
SPROCKETS.....	104
SPROCKET GUARD .....	104
SPROCKET LOCKING TAB .....	104
STABILIZED WHEEL KIT .....	14
STAND SCREW & NUT .....	79
STANDARD LEVERS .....	75
STARTER CHAIN .....	114
STARTER RELAY .....	128
STICKER SHEET (YCF) .....	61

SUBFRAMES .....	79
SUPERMOTARD CATCH TANK KIT .....	103
SUPERMOTARD TEFLON PROTECTION SET .....	103
SUPPORTING PLATE FOR HOUR METER .....	128
SWING ARMS .....	90
SWING ARM SLIDER .....	91
SWITCH REMOTE CUT OFF (50CC).....	128

## T

TAIL LIGHT .....	69
TANK BOLT.....	120
TANK COVER .....	81
TANK SHROUDS.....	63/66
TANK RECUPERATOR OIL.....	102
TAPER ROLLER BEARINGS .....	78
THREADLOCK.....	106
THROTTLE ADJUSTING SCREW.....	74
THROTTLE ASSEMBLY.....	75
THROTTLE CABLES .....	75
THROTTLE HANDLE.....	74
TIMING SPROCKET.....	114/130
TIRES .....	100/101
TIRE LEVER .....	106
TIRE VALVE CAPS .....	100
TOOLS .....	106/108
TRACK TAPE .....	50
TRAINING WHEEL KIT .....	14
TRIPLE CLAMPS.....	76/77
T-SHIRTS .....	52
TUBES .....	14/100

## U

UMBRELLA .....	52
----------------	----

## V

VALVE ADJUSTMENT TOOL.....	106
VALVE COVERS .....	118
VALVE PLUG.....	100
VALVE STEM SEAL .....	115

## W

WASHER FOR STEERING STEM NUT.....	78
WHEEL ASSEMBLY (COMPLETE) .....	14/93-96
WIRING HARNESS .....	128

## Y

YCF PLASTIC HANDLES ON SIDE PLATES.....	64/67
---	-------



YCF 50A

YCF 50E

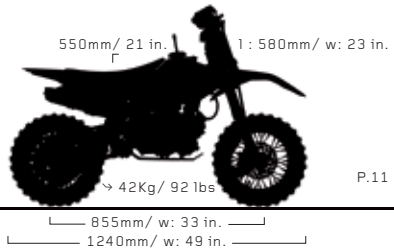

LITE F88S

LITE F125

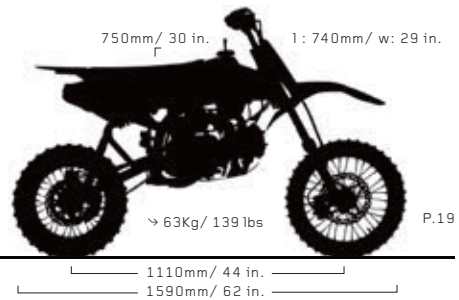
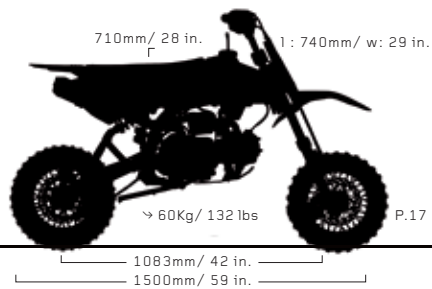

FACTORY SP2 150

FACTORY SP3 190

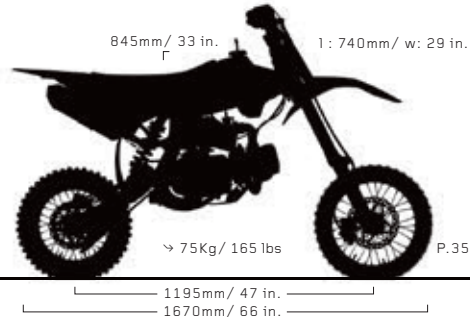
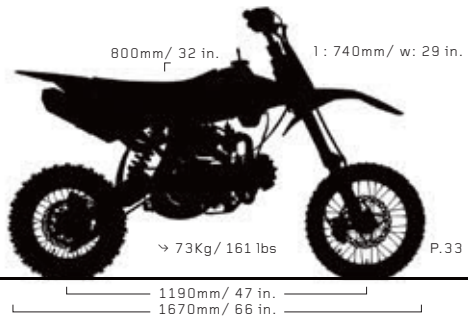

# START

START F88SE

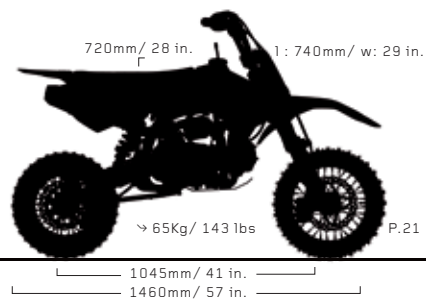

P.21

START F125  
START F125SE

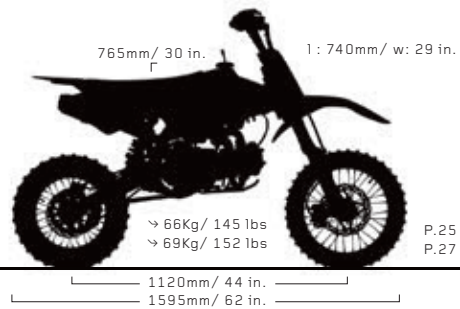

P.25  
P.27

# W88 ELECTRIC MOTOR

START W88

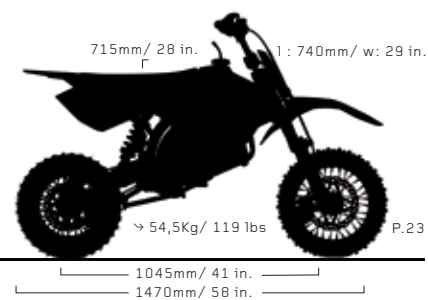

P.23

# PILOT

PILOT F125

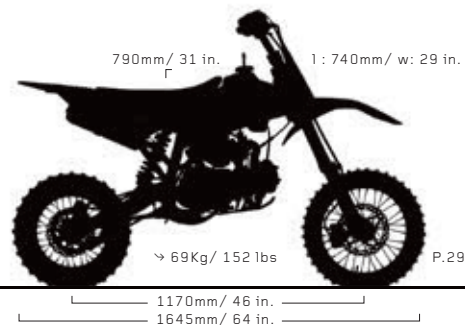

P.29

PILOT F150

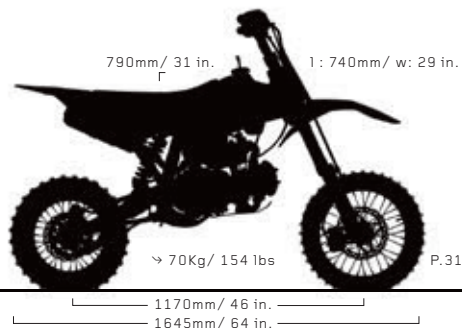

P.31

# SM

SM F125

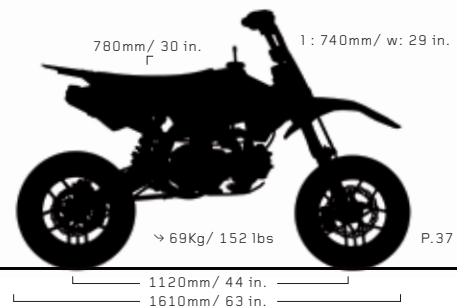

P.37

SM F155  
SM F190

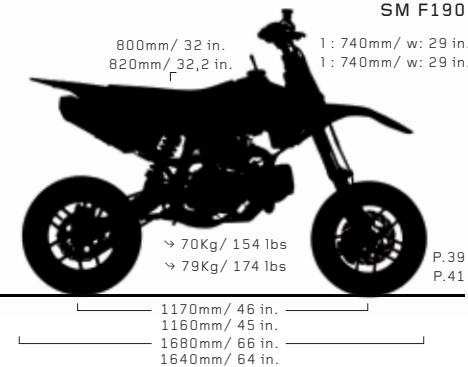

P.39  
P.41

# BIGY

BIGY 125 MX  
BIGY 150 MX

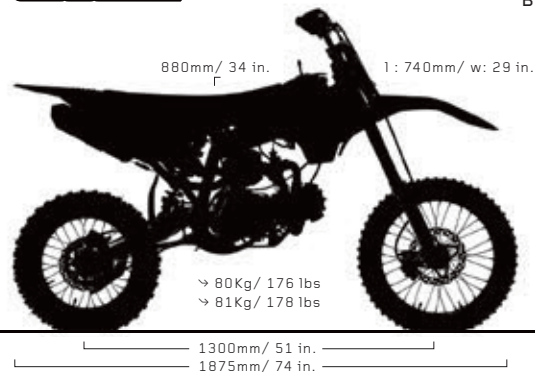

P.43  
P.45

# FACTORY

BIGY 190 MX FACTORY ZE  
BIGY 190 MX FACTORY DAYTONA®



P.47  
P.49



→ DISPONIBLE/ AVAILABLE PAGE 14

€ 1299

SPÉCIFICATIONS

MOTEUR: MONO CYLINDRE REFROIDISSEMENT  
 À AIR/ AUTOMATIQUE  
 FOURCHE INVERSÉE 530mm  
 SUSPENSION ARRIÈRE 200mm  
 PNEUS AV. & AR.: 2.50/10 - 2.50/10

SPECIFICATIONS

ENGINE TYPE: SINGLE CYLINDER AIR  
 COOLING/ AUTOMATIC GEAR BOX  
 530mm UPSD FORK  
 200mm REAR SUSPENSION  
 FRONT & REAR TIRES: 2.50/10 - 2.50/10

## 2021 YCF 50 A FUN FANATIC

POINTS FORTS & NOUVEAUTÉS 2021

MOTEUR 4T 50CC  
 STARTER AU GUIDON  
 DÉMARREUR ÉLECTRIQUE  
 PRISE RAPIDE DE CHARGEUR DE BATTERIE  
 POIGNÉE GAZ RÉGLABLE  
 42 KGS SEULEMENT  
 CLÉ DE CONTACT ÉTANCHE  
 FREIN AVANT ET ARRIÈRE HYDRAULIQUE

HIGHLIGHTS & 2021 NEW FEATURES

50CC 4 STROKE ENGINE  
 START BUTTON  
 ELECTRIC START  
 FAST BATTERY CHARGING  
 ADJUSTABLE THROTTLE  
 ONLY 92 LBS IN WEIGHT  
 WATERPROOF KEY CONTACTOR  
 HYDRAULIC BRAKE SYSTEM



YCF RECOMMENDS BARD AHL\* LUBRICANTS



**YCF50A**



550mm / 21 in.

 42Kg / 92 lbs

L : 580mm / W: 23 in.

855mm / 33 in.

1240mm / 49 in.



→ DISPONIBLE / AVAILABLE PAGE 14

€ 1699

#### SPÉCIFICATIONS

MOTEUR : ÉLECTRIQUE 1200W  
 BATTERIE LITHIUM 10aH  
 FOURCHE INVERSÉE 530mm  
 SUSPENSION ARRIÈRE 200mm  
 PNEU AV. & ARR. : 2.50/10 - 2.50/ 10

#### SPECIFICATIONS

1200W ELECTRIC  
 10 Ah LITHIUM BATTERY  
 530mm UPSD FORK  
 200mm REAR SUSPENSION  
 FRONT & REAR TIRES: 2.50/10 - 2.50/ 10

## 2021 YCF 50 E SILENCE BUILT TO PERFECTION

#### POINTS FORTS & NOUVEAUTÉS 2021

MOTEUR ÉLECTRIQUE NÉODYMIUM MAGNET DC 1200W/ 48V  
 BATTERIE LITHIUM/ TEMPS DE CHARGE 6H  
 AUTONOMIE 1H30  
 CHARGEUR LI-ION 110V/ 220V  
 RÉGLAGE PARENTAL (POTENTIOMÈTRE)  
 POIGNÉE GAZ INDICATEUR CHARGE BATTERIE  
 36KG SEULEMENT  
 RÉGLAGE DU TEMPS DE RÉPONSE À L'ACCÉLÉRATION  
 FREIN AVANT ET ARRIÈRE HYDRAULIQUE

#### HIGHLIGHTS & 2021 NEW FEATURES

1200W/ 48V NEODYMIUM MAGNET DC ENGINE  
 LITHIUM BATTERY/ CHARGING TIME 6 HOURS  
 BATTERY LIFE 1H30  
 LI-ION BATTERY CHARGER 110V/ 220V  
 SPEED DIAL (POTENTIOMETER)  
 THROTTLE WITH BATTERY CHARGE INDICATOR  
 ONLY 79 LBS IN WEIGHT  
 ACCELERATION RESPONSE TIME ADJUSTMENT  
 HYDRAULIC BRAKE SYSTEM



YCF RECOMMENDS BARDAHL\* LUBRICANTS



**YCF50E**



550mm/ 21 in.

 **36Kg/ 79 lbs**

L : 580mm/ W: 23 in.

855mm/ 33 in.

1240mm/ 49 in.



**KIT STABILISATEUR POUR YCF 50**  
 STABILIZER WHEEL KIT FOR YCF 50

→ YC50-2105

€ 119

**CHAMBRE À AIR POUR KIT STABILISATEUR**  
 TUBE FOR STABILIZER WHEEL KIT

03 → YC50-2106

€ 8

**ROUE POUR KIT STABILISATEUR**  
 WHEEL FOR STABILIZER WHEEL KIT

01 → YC50-2101

€ 19

**GARDE BOUE POUR KIT STABILISATEUR**  
 MUDGUARD FOR STABILIZER WHEEL KIT

02 → YC50-2103 (GAUCHE/ LEFT)  
 02 → YC50-2104 (DROIT/ RIGHT)

€ 25



PAGE 81 →

PAGE 75 →

PAGE 75 →

PAGE 100 →





PAGE 68 →

PAGE 81 →

PAGE 78 →

PAGE 129 →

PAGE 105 →

PAGE 81 →

PAGE 73 →



€ 1099

SPÉCIFICATIONS

MOTEUR: MONO CYLINDRE 4 TEMPS 88cc  
 4 VITESSES EMBRAYAGE SEMI AUTOMATIQUE  
 FOURCHE 600mm  
 SUSPENSION ARRIÈRE 265mm  
 PNEUS AV. & AR.: 250/10 - 300/10

SPECIFICATIONS

ENGINE TYPE: SINGLE CYLINDER 4 STROKE 88cc  
 4 GEARS (N1234) WITH AUTOMATIC CLUTCH  
 600mm FORK  
 265mm REAR SUSPENSION  
 FRONT & REAR TIRES: 250/10 - 300/10

2021 LITE F88S  
 LIGHT? YOU BET!

POINTS FORTS & NOUVEAUTÉS 2021

POIGNÉE DE GAZ RÉGLABLE  
 SEMI-AUTOMATIQUE  
 SELLE BASSE COMPATIBLE PAGE 80  
 FILTRE À AIR YCF  
 POIGNÉE CAOUTCHOUC YCF  
 SÉLECTEUR PLUS COURT  
 KIT RABAISSE AMORTISSEUR PAGE 92  
 TÉ FOURCHE CNC ET PONTET DE GUIDON 2 POSITIONS

HIGHLIGHTS & 2021 NEW FEATURES

ADJUSTABLE THROTTLE  
 SEMI-AUTOMATIC  
 COMPATIBLE LOW SEAT PAGE 80  
 YCF AIR FILTER  
 YCF GRIPS  
 SHORTER GEARSHIFT  
 HEIGHT ADJUSTMENT KIT PAGE 92  
 CNC CLAMP WITH ADJUSTABLE BAR MOUNT



YCF RECOMMENDS BARDAHL\* LUBRICANTS

**LITE**

**F885**



710mm / 28 in.

 60Kg / 132 lbs

L : 740mm / W : 29 in.

1083mm / 42 in.

1500mm / 42 in.



€ 1149

#### SPÉCIFICATIONS

**MOTEUR: MONO CYLINDRE 4 TEMPS 125cc**  
**4 VITESSES EMBRAYAGE**  
**FOURCHE 650mm**  
**SUSPENSION ARRIÈRE 270mm**  
**PNEUS AV. & AR.: 60/100/14 - 80/100/12**

#### SPECIFICATIONS

**ENGINE TYPE: SINGLE CYLINDER 4 STROKE 125cc**  
**4 GEARS (N1234)**  
**650mm FORK**  
**270mm REAR SUSPENSION**  
**FRONT & REAR TIRES: 60/100/14 - 80/100/12**

## 2021 LITE F125 LIGHT? YOU BET!

#### POINTS FORTS & NOUVEAUTÉS 2021

**POIGNÉE DE GAZ RÉGLABLE**  
**EMBRAYAGE MANUEL**  
**SELLE BASSE COMPATIBLE PAGE 80**  
**FILTRE À AIR YCF**  
**POIGNÉE CAOUTCHOUC YCF**  
**SÉLECTEUR PLUS COURT**  
**KIT RABAISSE AMORTISSEUR PAGE 92**  
**TÉ FOURCHE CNC ET PONTET DE GUIDON 2 POSITIONS**

#### HIGHLIGHTS & 2021 NEW FEATURES

**ADJUSTABLE THROTTLE**  
**MANUAL CLUTCH**  
**COMPATIBLE LOW SEAT PAGE 80**  
**YCF AIR FILTER**  
**YCF GRIPS**  
**SHORTER GEARSHIFT**  
**HEIGHT ADJUSTMENT KIT PAGE 92**  
**CNC CLAMP WITH ADJUSTABLE BAR MOUNT**



YCF RECOMMENDS BARDAHL\* LUBRICANTS

**LITE**

**F125**

750mm / 30 in.



 63Kg / 139 lbs

L : 740mm / W : 29 in.

1110mm / 44 in.

1590mm / 62 in.



€ 1499

SPÉCIFICATIONS

MOTEUR: MONO CYLINDRE 4 TEMPS 88cc  
 4 VITESSES EMBRAYAGE SEMI AUTOMATIQUE  
 FOURCHE INVERSÉE 600mm  
 SUSPENSION ARRIÈRE RÉGLABLE 265mm  
 PNEUS AV. & AR.: 60/100/12 - 300/10

SPECIFICATIONS

ENGINE TYPE: SINGLE CYLINDER 4 STROKE 88cc  
 4 GEARS (N1234) WITH AUTOMATIC CLUTCH  
 600mm UPSD FORK  
 265mm ADJUSTABLE REAR SUSPENSION  
 FRONT & REAR TIRES: 60/100/12 - 300/10

2021 START F88SE  
 MAGIC BUTTON

POINTS FORTS & NOUVEAUTÉS 2021

DÉMARREUR ÉLECTRIQUE  
 SEMI-AUTOMATIQUE  
 POIGNÉE DE GAZ RÉGLABLE  
 BOUTON DE DÉMARREUR ÉTANCHE  
 SELLE BASSE COMPATIBLE PAGE 80  
 FILTRE À AIR YCF  
 POIGNÉE CAOUTCHOUC YCF  
 SÉLECTEUR PLUS COURT  
 TÉ FOURCHE CNC ET PONTET DE GUIDON 2 POSITIONS

HIGHLIGHTS & 2021 NEW FEATURES

ELECTRIC STARTER  
 SEMI-AUTOMATIC  
 ADJUSTABLE THROTTLE  
 WATERPROOF START BUTTON  
 COMPATIBLE LOW SEAT PAGE 80  
 YCF AIR FILTER  
 YCF GRIPS  
 SHORTER GEARSHIFT  
 CNC CLAMP WITH ADJUSTABLE BAR MOUNT



YCF RECOMMENDS BARDAHL\* LUBRICANTS

**START**

**F88S**



720mm/ 28 in.

 65Kg/ 143 lbs

L : 740mm/ W: 29 in.

1045mm/ 41 in.

1460mm/ 57 in.



€ 1999

SPÉCIFICATIONS

MOTEUR : ÉLECTRIQUE 1000W/ 60V  
 BATTERIE LITHIUM 20Ah  
 FOURCHE INVERSÉE 600mm  
 SUSPENSION ARRIÈRE RÉGLABLE 265mm  
 PNEUS AV. & AR. : 60/100/12 - 300/10

SPECIFICATIONS

ENGINE TYPE: 1000W/ 60V ELECTRIC  
 20Ah LITHIUM BATTERY  
 600mm UPSD FORK  
 265mm ADJUSTABLE REAR SUSPENSION  
 FRONT & REAR TIRES: 60/100/12 - 300/10

2021 START W88  
 THE NEW ERA OF ELECTRIC

POINTS FORTS & NOUVEAUTÉS 2021

MOTEUR BRUSHLESS 1000W/ 60V  
 BATTERIE LITHIUM/ TEMPS DE CHARGE 7H  
 AUTOMIE 1H00  
 CHARGEUR LI-ION 110V/ 220V  
 POIGNÉE DE GAZ AVEC INDICATEUR DE CHARGE DE BATTERIE  
 RÉGLAGE PARENTAL (POTENTIOMETRE)  
 54,5 KG SEULEMENT  
 PROTECTION DE CHAÎNE  
 PROTECTION MOTEUR/ BATTERIE PAR CAISSON FIBRE DE VERRE  
 RÉGLAGE DU TEMPS DE RÉPONSE À L'ACCÉLÉRATION  
 SELLE BASSE COMPATIBLE PAGE 80  
 KIT RABAISSE ADAPTABLE PAGE 92

HIGHLIGHTS & 2021 NEW FEATURES

1000W/ 60V BRUSHLESS ENGINE (BDLC)  
 LITHIUM BATTERY/ CHARGING TIME 7 HOURS  
 BATTERY LIFE 1:00  
 LI-ION BATTERY CHARGER 110V/ 220V  
 THROTTLE WITH BATTERY CHARGE INDICATOR  
 SPEED DIAL (POTENTIOMETER)  
 ONLY 119 LBS IN WEIGHT  
 FULL COVERAGE CHAIN GUARD  
 FIBER GLASS FULL COVERAGE OF THE ENGINE  
 ACCELERATION RESPONSE TIME ADJUSTMENT  
 COMPATIBLE LOW SEAT PAGE 80  
 HEIGHT ADJUSTMENT KIT PAGE 92



YCF RECOMMENDS BARD AHL\* LUBRICANTS



**START**

**88** ELECTRIC MOTOR



715mm / 28 in.

 54,5Kg / 119 lbs

L : 740mm / W : 29 in.

1045mm / 41 in.

1470mm / 58 in.



€ 1399

SPÉCIFICATIONS

MOTEUR: MONO CYLINDRE 4 TEMPS 125cc  
 4 VITESSES EMBRAYAGE  
 FOURCHE INVERSÉE 660mm  
 SUSPENSION ARRIÈRE RÉGLABLE 270mm  
 PNEUS AV. & AR.: 60/100/14 - 80/100/12

SPECIFICATIONS

ENGINE TYPE: SINGLE CYLINDER 4 STROKE 125cc  
 4 GEARS (N1234)  
 660mm UPSD FORK  
 270mm ADJUSTABLE REAR SUSPENSION  
 FRONT & REAR TIRES: 60/100/14 - 80/100/12

2021 START F125  
 FAST & EASY

POINTS FORTS & NOUVEAUTÉS 2021

POIGNÉE DE GAZ RÉGLABLE  
 JOINT ÉTANCHE DE COLONNE DE DIRECTION  
 SELLE BASSE COMPATIBLE PAGE 80  
 KIT RABASSE ADAPTABLE PAGE 92  
 FILTRE À AIR YCF  
 POIGNÉE CAOUTCHOUC YCF  
 SÉLECTEUR PLUS COURT  
 TÉ FOURCHE CNC ET PONTET DE GUIDON 2 POSITIONS

HIGHLIGHTS & 2021 NEW FEATURES

ADJUSTABLE THROTTLE  
 SEALING WASHER FOR STEERING STEM  
 COMPATIBLE LOW SEAT PAGE 80  
 HEIGHT ADJUSTMENT KIT PAGE 92  
 YCF AIR FILTER  
 YCF GRIPS  
 SHORTER GEARSHIFT  
 CNC CLAMP WITH ADJUSTABLE BAR MOUNT



YCF RECOMMENDS BARDAHL\* LUBRICANTS

**START**

**F125**

765mm/ 30 in.



 **66Kg/ 145 lbs**

L : 740mm/ W : 29 in.

1120mm/ 44 in.

1595mm/ 62 in.



€ 1549

#### SPÉCIFICATIONS

**MOTEUR: MONO CYLINDRE 4 TEMPS 125cc**  
**4 VITESSES EMBRAYAGE SEMI AUTOMATIQUE**  
**FOURCHE INVERSÉE 660mm**  
**SUSPENSION ARRIÈRE RÉGLABLE 270mm**  
**PNEUS AV. & AR.: 60/100/14 - 80/100/12**

#### SPECIFICATIONS

**ENGINE TYPE: SINGLE CYLINDER 4 STROKE 125cc**  
**4 GEARS (N1234) WITH AUTOMATIC CLUTCH**  
**660mm UPSD FORK**  
**270mm ADJUSTABLE REAR SUSPENSION**  
**FRONT & REAR TIRES: 60/100/14 - 80/100/12**

## 2021 START F125SE THE ULTIMATE BATTLE MACHINE

#### POINTS FORTS & NOUVEAUTÉS 2021

**DÉMARREUR ÉLECTRIQUE SEMI-AUTOMATIQUE**  
**POIGNÉE DE GAZ RÉGLABLE**  
**SELLE BASSE COMPATIBLE PAGE 80**  
**FILTRE À AIR YCF**  
**POIGNÉE CAOUTCHOUC YCF**  
**SÉLECTEUR PLUS COURT**  
**TÉ FOURCHE CNC ET PONTET DE GUIDON 2 POSITIONS**

#### HIGHLIGHTS & 2021 NEW FEATURES

**ELECTRIC START SEMI-AUTOMATIC**  
**ADJUSTABLE THROTTLE**  
**COMPATIBLE LOW SEAT PAGE 80**  
**YCF AIR FILTER**  
**YCF GRIPS**  
**SHORTER GEARSHIFT**  
**CNC CLAMP WITH ADJUSTABLE BAR MOUNT**



YCF RECOMMENDS BARDAHL\* LUBRICANTS

**START**

**F125S**

765mm / 30 in.



 **69Kg / 152 lbs**

L : 740mm / W : 29 in.

1120mm / 44 in.

1595mm / 62 in.



€ 1599

#### SPÉCIFICATIONS

**MOTEUR: MONO CYLINDRE**  
**4 TEMPS 125cc/ 4 VITESSES**  
**FOURCHE INVERSÉE 735mm**  
**SUSPENSION ARRIÈRE RÉGLABLE 330mm**  
**PNEUS AV. & AR.: 60/100/14 - 80/100/12**

#### SPECIFICATIONS

**ENGINE TYPE: SINGLE CYLINDER**  
**4 STROKE 125cc/ 4 GEARS (N1234)**  
**FORK: 735mm UPSD FORK**  
**REAR SUSPENSION: 330mm ADJUSTABLE**  
**FRONT & REAR TIRES: 60/100/14 - 80/100/12**

## 2021 PILOT F125 WORLD CLASS SIZE

#### POINTS FORTS & NOUVEAUTÉS 2021

**POIGNÉE DE GAZ RÉGLABLE**  
**BOÎTE À AIR**  
**POIGNÉE CAOUTCHOUC YCF**  
**SÉLECTEUR PLUS COURT**  
**TÉ FOURCHE CNC ET PONTET DE GUIDON 2 POSITIONS**

#### HIGHLIGHTS & 2021 NEW FEATURES

**ADJUSTABLE THROTTLE**  
**AIR BOX**  
**YCF GRIPS**  
**SHORTER GEARSHIFT**  
**CNC CLAMP WITH ADJUSTABLE BAR MOUNT**



YCF RECOMMENDS BARDAHL\* LUBRICANTS

# PILOT

# F125



790mm / 31 in.

 69Kg / 152 lbs

L : 740mm / W : 29 in.

1170mm / 46 in.

1645mm / 64 in.



€ 1749

#### SPÉCIFICATIONS

MOTEUR: MONOCYLINDRE 4 TEMPS  
150cc/ 4 VITESSES (N1234)  
FOURCHE INVERSÉE 735mm  
SUSPENSION ARRIÈRE RÉGLABLE 330mm  
PNEUS AV. & AR.: 60/100/14 - 80/100/12

#### SPECIFICATIONS

ENGINE TYPE: SINGLE CYLINDER 4 STROKE  
150cc/ 4 GEARS (N1234)  
735mm UPSD FORK  
330mm ADJUSTABLE REAR SUSPENSION  
FRONT & REAR TIRES: 60/100/14 - 80/100/12

## 2021 PILOT F150 THE ULTIMATE 150

#### POINTS FORTS & NOUVEAUTÉS 2021

BOÎTE À AIR  
POIGNÉE CAOUTCHOUC YCF  
SÉLECTEUR PLUS COURT  
TÉ FOURCHE CNC ET PONTET DE GUIDON 2 POSITIONS

#### HIGHLIGHTS & 2021 NEW FEATURES

AIR BOX  
YCF GRIPS  
SHORTER GEARSHIFT  
CNC CLAMP WITH ADJUSTABLE BAR MOUNT



YCF RECOMMENDS BARDAHL\* LUBRICANTS



# PILOT

# F150

790mm / 31 in.



 65Kg / 154 lbs

L : 740mm / W : 29 in.

1170mm / 46 in.

1645mm / 64 in.

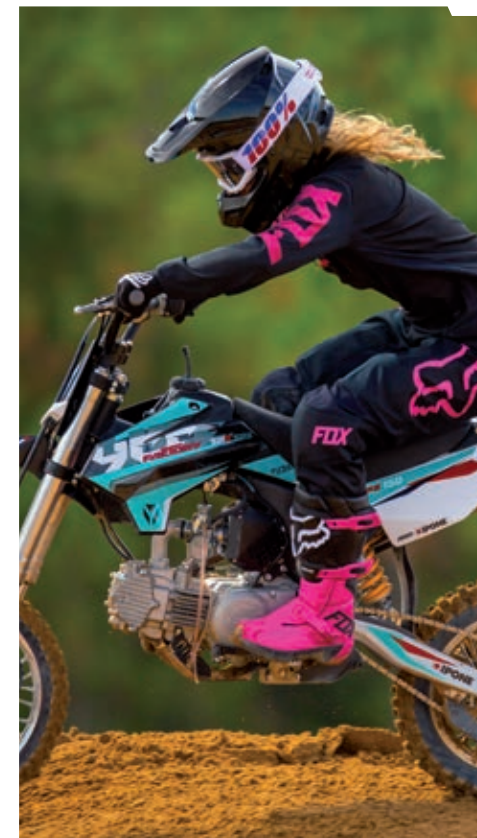

€ 2399

#### SPÉCIFICATIONS

MOTEUR : MONOCYLINDRE 4 TEMPS  
 150cc TYPE KLX / 4 VITESSES  
 FOURCHE INVERSÉE RÉGLABLE 735mm  
 SUSPENSION ARRIÈRE RÉGLABLE 330mm  
 PNEUS AV. & AR. : 60/100/14 - 80/100/12 ARRO®

#### SPECIFICATIONS

ENGINE TYPE: SINGLE CYLINDER 4 STROKE  
 150cc KLX TYPE / 4 GEARS (N1234)  
 735mm ADJUSTABLE UPSD FORK  
 330mm ADJUSTABLE REAR SUSPENSION  
 FRONT & REAR TIRES: 60/100/14 - 80/100/12 ARRO®

## 2021 FACTORY SP2 150 RACE READY

#### POINTS FORTS & NOUVEAUTÉS 2021

MOYEURS AVANT / ARRIÈRE ALUMINIUM CNC  
 COURONNE 5 TROUS  
 PNEUS ARRO® AVANT / ARRIÈRE  
 CERCEAU DE ROUE ALUMINIUM 7116 SILVER  
 GRAISSEUR SUR COLONNE DE DIRECTION  
 SILENCIEUX RACING  
 POIGNÉE CAOUTCHOUC YCF  
 BAVETTE AMORTISSEUR  
 TÉ FOURCHE CNC ET PONTET DE GUIDON 2 POSITIONS  
 BRAS OSCILLANT ALUMINIUM 420mm

#### HIGHLIGHTS & 2021 NEW FEATURES

ALUMINIUM CNC FRONT / REAR HUBS  
 REAR SPROCKET 5 FIXATIONS POINTS  
 FRONT / REAR ARRO® TIRES  
 ALUMINIUM 7116 SILVER RIMS  
 GREASING ON STEERING STEM  
 RACING MUFFLER  
 YCF GRIPS  
 MUD FLAP  
 CNC CLAMP WITH ADJUSTABLE BAR MOUNT  
 420mm ALUMINIUM SWING ARM



YCF RECOMMENDS BARDAHL\* LUBRICANTS

**FACTORY**

**150 SP2**

800mm / 32 in.



 73Kg / 161 lbs

L : 740mm / W : 29 in.

1190mm / 47 in.

1670mm / 66 in.



€ 3399

SPÉCIFICATIONS

MOTEUR: MONO CYLINDRE 4T, 4 SOUPAPES 190cc  
 DAYTONA® ANIMA®/ 4 VITESSES  
 FOURCHE ENGI® INVERSÉE RÉGLABLE 800mm  
 SUSPENSION ARRIÈRE ENGI® RÉGLABLE 335mm  
 PNEUS AV. & AR. ARRO® : 60/100/14 - 80/100/12  
 CARBURATEUR NIBBI® 28

SPECIFICATIONS

ENGINE TYPE: DAYTONA® ANIMA® SINGLE CYLINDER 4V  
 4 STROKE 190cc/ 4 GEARS (N1234)  
 800mm ENGI® UPSD ADJUSTABLE FORK  
 335mm ENGI® ADJUSTABLE REAR SUSPENSION  
 FRONT & REAR ARRO® TIRES: 60/100/14 - 80/100/12  
 NIBBI® 28 CARBURETOR

**DAYTONA ENGI® ARRO™**



YCF RECOMMENDS BARDAHL® LUBRICANTS

**2021 FACTORY SP3 190  
 CATCH ME IF YOU CAN**

POINTS FORTS & NOUVEAUTÉS 2021

BRAS OSCILLANT 460mm  
 TÉ 170mm  
 MOYEURS AVANT/ ARRIÈRE ALUMINIUM CNC  
 POIGNÉE CAOUTCHOUC YCF  
 BAVETTE AMORTISSEUR  
 TÉ FOURCHE CNC ET PONTET DE GUIDON 2 POSITIONS  
 GUIDON YCF 28,6MM  
 REPOSE PIED INOX  
 PÉDALE DE FREIN ALUMINIUM  
 GUIDE CHAÎNE RENFORCÉ

HIGHLIGHTS & 2021 NEW FEATURES

18 IN. SWINGARM  
 7 IN. TRIPLE CLAMPS  
 ALUMINIUM CNC FRONT/ REAR HUBS  
 YCF GRIPS  
 MUD FLAP  
 CNC CLAMP WITH ADJUSTABLE BAR MOUNT  
 YCF FAT BAR 28,6mm HANDLEBAR  
 INOX FOOT PEGS  
 ALUMINIUM BRAKE PEDAL  
 REINFORCED CHAIN GUIDE

**FACTORY**

**190 SP3**  
**DAYTONA**

845mm / 33 in.



 **75Kg / 165 lbs**

L : 740mm / W : 29 in.

1195mm / 47 in.

1670mm / 66 in.



€ 1799

#### SPÉCIFICATIONS

**MOTEUR: MONO CYLINDRE 4 TEMPS 125cc**  
**4 VITESSES EMBRAYAGE**  
**FOURCHE INVERSÉE 660mm**  
**SUSPENSION ARRIÈRE RÉGLABLE 270mm**  
**PNEUS AV. & AR.: 100/90/12 - 120/80/12**

#### SPECIFICATIONS

**ENGINE TYPE: SINGLE CYLINDER 4 STROKE 125cc**  
**4 GEARS (N1234)**  
**660mm UPSD FORK**  
**270mm ADJUSTABLE REAR SUSPENSION**  
**FRONT & REAR TIRES: 100/90/12 - 120/80/12**

## 2021 SM F125 SUPERMOTO, SUPER FUN!

#### POINTS FORTS & NOUVEAUTÉS 2021

**MOTEUR 125 ZONGSHEN FIDDY RACER**  
**POIGNÉE DE GAZ RÉGLABLE**  
**PNEUS KENDA K702**  
**NOUVELLES ROUES YCF**  
**SELLE BASSE COMPATIBLE PAGE 80**  
**KIT RABAISSE ADAPTABLE PAGE 92**  
**POIGNÉE CAOUTCHOUC YCF**  
**TÉ FOURCHE CNC ET PONTET DE GUIDON 2 POSITIONS**

#### HIGHLIGHTS & 2021 NEW FEATURES

**ZONGSHEN ENGINE 125 FIDDY RACER**  
**ADJUSTABLE THROTTLE**  
**KENDA TIRES K702**  
**NEW YCF WHEELS**  
**COMPATIBLE LOW SEAT PAGE 80**  
**HEIGHT ADJUSTMENT KIT PAGE 92**  
**YCF GRIPS**  
**CNC CLAMP WITH ADJUSTABLE BAR MOUNT**



YCF RECOMMENDS BARDAHL\* LUBRICANTS



**F125**

780mm / 30 in.



 **69Kg / 152 lbs**

L : 740mm / W : 29 in.

1120mm / 44 in.

1610mm / 63 in.



€ 2199

**SPÉCIFICATIONS**

**MOTEUR: MONO CYLINDRE**  
**4 TEMPS 155cc ZONGSHEN/ 4 VITESSES (N1234)**  
**FOURCHE INVERSÉE 735mm**  
**SUSPENSION ARRIÈRE RÉGLABLE 310mm**  
**PNEUS AV. & AR.: 100/90/12 - 120/80/12**

**SPECIFICATIONS**

**ENGINE TYPE: SINGLE CYLINDER**  
**4 STROKE ZONGSHEN 155cc/ 4 GEARS (N1234)**  
**735mm UPSD FORK**  
**310mm ADJUSTABLE REAR SUSPENSION**  
**FRONT & REAR TIRES: 100/90/12 - 120/80/12**

**2021 SM F155  
 ADRENALINE RUSH**

**POINTS FORTS & NOUVEAUTÉS 2021**

**PNEUS KENDA® K702**  
**MOTEUR ZONGSHEN® W155**  
**NOUVELLES ROUES YCF**  
**FILTRE À AIR YCF**  
**FOURCHE RÉGLABLE**  
**POIGNÉE CAOUTCHOUC YCF**  
**TÉ FOURCHE CNC ET POINTET DE GUIDON 2 POSITIONS**

**HIGHLIGHTS & 2021 NEW FEATURES**

**KENDA® TIRES**  
**ZONGSHEN® ENGINE W155**  
**NEW YCF WHEELS**  
**YCF AIR FILTER**  
**ADJUSTABLE FRONT FORK**  
**YCF GRIPS**  
**CNC CLAMP WITH ADJUSTABLE BAR MOUNT**



YCF RECOMMENDS BARDAHL\* LUBRICANTS





**F155**



800mm / 32 in.

 70Kg / 154 lbs

L : 740mm / W : 29 in.

1170mm / 46 in.

1680mm / 66 in.



€ 3299

**NEW  
2021**

**2021 SM F190  
CATCH ME IF YOU CAN**

**SPÉCIFICATIONS**

MOTEUR: MONO CYLINDRE 4T, 4 SOUPAPES 190cc  
 DAYTONA® ANIMA®/ 4 VITESSES  
 FOURCHE ENGI® INVERSÉE RÉGLABLE 735mm  
 SUSPENSION ARRIÈRE DNM® RÉGLABLE 310mm  
 PNEUS AV. & AR. 100/90/12 - 120/80/12  
 CARBURATEUR NIBBI® PE28

**SPECIFICATIONS**

ENGINE TYPE: DAYTONA® ANIMA® SINGLE CYLINDER 4V  
 4 STROKE 190cc/ 4 GEARS (N1234)  
 735mm ENGI® UPSD ADJUSTABLE FORK  
 310mm DNM® ADJUSTABLE REAR SUSPENSION  
 FRONT & REAR TIRES: 100/90/12 - 120/80/12  
 NIBBI® PE28 CARBURETOR

**POINTS FORTS**

NOUVELLES ROUES YCF  
 PNEUS KENDA® K702  
 LIGNE D'ÉCHAPPEMENT RACING DOUBLE SORTIE  
 AMORTISSEUR DNM 1000LBS  
 MAÎTRE CYLINDRE AVANT RACING  
 KIT FREIN RADIAL AVANT ET ARRIÈRE  
 DISQUE FLOTTANT 220MM

**HIGHLIGHTS**

NEW YCF WHEELS  
 KENDA® TIRE K702  
 COMPLETE RACING EXHAUST TWIN  
 DNM SHOCK ABSORBER 1000 LBS  
 FRONT RACING MASTER CYLINDER  
 FRONT AND REAR RADIAL BRAKE KIT  
 SEMI FLOATING BRAKE ROTOR 220MM

**DAYTONA ENGI KENDA**



YCF RECOMMENDS BARD AHL\* LUBRICANTS



# F150 DAYTONA®



820mm / 32 in.

 79Kg / 174 lbs

L : 740mm / W : 29 in.

1160mm / 45 in.

1640mm / 64 in.



€ 1999

SPÉCIFICATIONS

MOTEUR: MONO CYLINDRE  
 4 TEMPS 125cc/ 4 VITESSES  
 FOURCHE INVERSÉE 785mm  
 SUSPENSION ARRIÈRE RÉGLABLE 355mm  
 PNEUS AV. & AR.: 70/100/17 - 90/100/14

SPECIFICATIONS

ENGINE TYPE: SINGLE CYLINDER  
 4 STROKE 125cc/ 4 GEARS (N1234)  
 FORK: 785mm UPSD FORK  
 REAR SUSPENSION: 355mm ADJUSTABLE  
 FRONT & REAR TIRES: 70/100/17 - 90/100/14

2021 BIGY 125 MX  
 EASY TO PICK UP

POINTS FORTS & NOUVEAUTÉS 2021

ROUE AVANT 17'/ ARRIÈRE 14'  
 BOÎTE À AIR  
 POIGNÉE CAOUTCHOUC YCF  
 BAVETTE AMORTISSEUR  
 TÉ FOURCHE CNC ET PONTET DE GUIDON 2 POSITIONS  
 LEVIER DE FREIN PLIABLE  
 SÉLECTEUR PLUS COURT

HIGHLIGHTS & 2021 NEW FEATURES

FRONT 17'/ REAR 14' WHEEL  
 AIR BOX  
 YCF GRIPS  
 MUD FLAP  
 CNC CLAMP WITH ADJUSTABLE BAR MOUNT  
 FOLDABLE FRONT BRAKE LEVER  
 SHORTER GEARSHIFT



YCF RECOMMENDS BARDAHL\* LUBRICANTS



**125 MX**



880mm / 34 in.

 80Kg / 176 lbs

L : 740mm / W : 29 in.

1300mm / 51 in.

1875mm / 74 in.



€ 2199

SPÉCIFICATIONS

MOTEUR: MONO CYLINDRE  
 4 TEMPS 150cc/ 4 VITESSES  
 FOURCHE INVERSÉE 785mm  
 SUSPENSION ARRIÈRE RÉGLABLE 355mm  
 PNEUS AV. & AR.: 70/100/17 - 90/100/14

SPECIFICATIONS

ENGINE TYPE: SINGLE CYLINDER  
 4 STROKE 150cc/ 4 GEARS (N1234)  
 FORK: 785mm UPSD FORK  
 REAR SUSPENSION: 355mm ADJUSTABLE  
 FRONT & REAR TIRES: 70/100/17 - 90/100/14

2021 BIGY 150 MX  
 BIGGER! FASTER! STRONGER!

POINTS FORTS & NOUVEAUTÉS 2021

ROUE AVANT 17"/ ARRIÈRE 14'  
 BOÎTE À AIR  
 POIGNÉE CAOUTCHOUC YCF  
 BAVETTE AMORTISSEUR  
 TÉ FOURCHE CNC ET PONTET DE GUIDON 2 POSITIONS  
 LEVIER DE FREIN PLIABLE  
 SÉLECTEUR PLUS COURT

HIGHLIGHTS & 2021 NEW FEATURES

FRONT 17"/ REAR 14' WHEEL  
 AIR BOX  
 YCF GRIPS  
 MUD FLAP  
 CNC CLAMP WITH ADJUSTABLE BAR MOUNT  
 FOLDABLE FRONT BRAKE LEVER  
 SHORTER GEARSHIFT



YCF RECOMMENDS BARDAHL\* LUBRICANTS



**150 MX**

880mm / 34 in.



 **81Kg / 178 lbs**

L : 740mm / W : 29 in.

1300mm / 51 in.

1875mm / 74 in.



€ 2999

#### SPÉCIFICATIONS

**MOTEUR: MONOCYLINDRE 4 TEMPS**  
**190cc ZONGSHEN/ 5 VITESSES**  
**FOURCHE INVERSÉE RÉGLABLE 800mm**  
**SUSPENSION ARRIÈRE RÉGLABLE 355mm**  
**PNEUS AV. & AR.: 70/100/17 - 90/100/14 ARRO®**  
**CARBURATEUR NIBBI® 28**

#### SPECIFICATIONS

**ENGINE TYPE: SINGLE CYLINDER 4 STROKE**  
**190cc ZONGSHEN/ 5 GEARS**  
**800mm ADJUSTABLE UPSD FORK**  
**355mm ADJUSTABLE REAR SUSPENSION**  
**FRONT & REAR TIRES: 70/100/17 - 90/100/14 ARRO®**  
**NIBBI® 28 CARBURETOR**

## 2021 BIGGY 190 MX ZE FACTORY ELECTRIC START

#### POINTS FORTS & NOUVEAUTÉS 2021

**ROUE AVANT 17'/ ARRIÈRE 14'**  
**BOÎTE À AIR**  
**JANTES ALUMINIUM 7116**  
**MOYEURS AVANT/ ARRIÈRE ALUMINIUM CNC**  
**DÉMARREUR ÉLECTRIQUE**  
**POIGNÉE CAOUTCHOUC YCF**  
**BAVETTE AMORTISSEUR**  
**TÉ FOURCHE CNC ET PONTET DE GUIDON 2 POSITIONS**  
**REPOSE PIED INOX**  
**PÉDALE DE FREIN ALUMINIUM**  
**GUIDE CHAÎNE RENFORCÉ**

#### HIGHLIGHTS & 2021 NEW FEATURES

**FRONT 17'/ REAR 14' WHEEL**  
**AIR BOX**  
**ALUMINIUM 7116 RIMS**  
**ALUMINIUM FRONT/ REAR CNC HUBS**  
**ELECTRIC START**  
**YCF GRIPS**  
**MUD FLAP**  
**CNC CLAMP WITH ADJUSTABLE BAR MOUNT**  
**INOX FOOT PEGS**  
**ALUMINIUM BRAKE PEDAL**  
**REINFORCED CHAIN GUIDE**



YCF RECOMMENDS BARDAHL\* LUBRICANTS





190 MX<sup>+</sup> FACTORY



890mm / 35 in.

 89Kg / 196 lbs

L : 740mm / W : 29 in.

1305mm / 51 in.

1880mm / 74 in.



€ 3499

SPÉCIFICATIONS

MOTEUR: MONO CYLINDRE 4T, 4 SOUPAPES 190cc  
 DAYTONA® ANIMA®/ 4 VITESSES  
 MOTEUR 4 VITESSES  
 FOURCHE ENGI® INVERSÉE RÉGLABLE 800mm  
 SUSPENSION ARRIÈRE ENGI® RÉGLABLE 355mm  
 PNEUS AV. & AR.: 70/100/17 - 90/100/14 ARRO®  
 CARBURATEUR NIBBI® 28

SPECIFICATIONS

ENGINE TYPE: DAYTONA® ANIMA® SINGLE CYLINDER 4V  
 4 STROKE 190cc/ 4 GEARS (N1234)  
 4 SPEED ENGINE  
 800mm ENGI® UPSD ADJUSTABLE FORK  
 355mm ENGI® ADJUSTABLE REAR SUSPENSION  
 FRONT & REAR TIRES: 70/100/17 - 90/100/14 ARRO®  
 NIBBI® 28 CARBURETOR

**DAYTONA ENGI® ARRO™**



YCF RECOMMENDS BARDAHL® LUBRICANTS

**2021 BIGY 190 MX FACTORY DAYTONA  
 FIRST TO THE FINISH LINE**

POINTS FORTS & NOUVEAUTÉS 2021

BOÎTE À AIR  
 SURMOUSSE DE GUIDON CAOUTCHOUC 3D  
 MOTEUR 4 VITESSES  
 BRAS OSCILLANT ALUMINIUM  
 REPOSE PIED INOX  
 PÉDALE DE FREIN ALUMINIUM  
 POIGNÉE CAOUTCHOUC YCF  
 BAVETTE AMORTISSEUR  
 TÉ FOURCHE CNC ET PONTET DE GUIDON 2 POSITIONS  
 GUIDON YCF 28,6MM  
 PÉDALE DE FREIN ALUMINIUM  
 GUIDE CHAÎNE RENFORCÉ

HIGHLIGHTS & 2021 NEW FEATURES

AIR BOX  
 RUBBER BAR PAD  
 DAYTONA 4 SPEED ENGINE  
 ALUMINIUM SWING ARM  
 INOX FOOTPEGS  
 ALUMINIUM BRAKE PEDAL  
 YCF GRIPS  
 MUD FLAP  
 CNC CLAMP WITH ADJUSTABLE BAR MOUNT  
 YCF FAT BAR 28,6mm HANDLEBAR  
 ALUMINIUM BRAKE PEDAL  
 REINFORCED CHAIN GUIDE



# 190 MX FACTORY DAYTONA



890mm / 35 in.

 84 Kg / 185 lbs

L : 740mm / W : 29 in.

1305mm / 51 in.

1880mm / 74 in.

**PADDOCK  
PADDOCK**



**ORIFLAMME**  
FLAG

→ YCF-FLAG-3M (3 METERS-118 in.)

€ 129



**TONNELLE 3 X 3M YCF (100 % ÉTANCHE) VELCRO INTÉGRAL AUTOUR DU TOIT**  
YCF PIT TENT 3 X 3M (100 % WATERPROOF) INTEGRAL VELCRO AROUND THE ROOF

→ TONNELLEYCF-3

€ 199



**RUBALISE DE TERRAIN (ROULEAU DE 100 MÈTRES)**  
BANNER ROLL (100 METERS ROLL)

→ RUB-1

€ 9



**BANDEROLE DE TERRAIN EN FEUTRINE 1 X 25M**  
BANNER ROLL 1 X 25M

→ FEUTRINE-1

€ 99



**BANNER YCF 2 X 0,50M**  
YCF BANNER 2 X 0,50M

→ BANNER

€ 29



**BÂCHE MOTO**  
MOTORCYCLE COVER

→ BIKECOVER-BL

€ 29

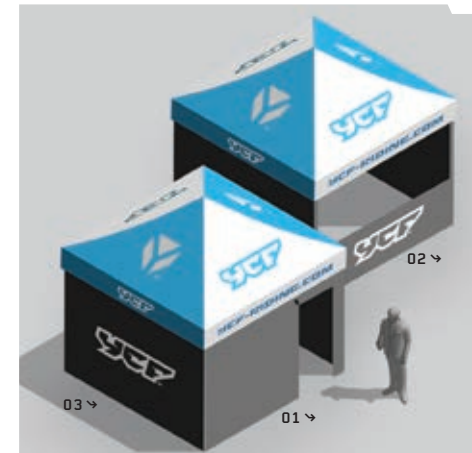

**CÔTÉ DE TONNELLE 3 X 3M AVEC PORTE ZIPPÉE**  
PIT TENT SIDE 3 X 3M WITH ZIP DOOR

01 → PORTE-1

€ 49

**DEMI CÔTÉ DE TONNELLE**  
PIT TENT HALF SIDE

02 → DEMICOTE-1

€ 29

**CÔTÉ DE TONNELLE 3 X 3M**  
PIT TENT SIDE 3 X 3M

03 → COTE-1

€ 39



**CHAISE PLIABLE YCF**  
YCF FOLDING CHAIR

→ CHAIR-BL

€ 29



**TREPIED ALUMINIUM NOIR/ BLEU/ VERT/ ORANGE/ ROUGE - HAUTEUR 40 cm**

ALUMINIUM BIKE STAND BLACK/ BLUE/ GREEN/ ORANGE/ RED - HEIGHT 15,7 in.

→ TREPIED + COLOR

€ 79

**NEW  
2021**



**BÉQUILLE ROUE AR RÉGLABLE AVEC ROULETTE**

REAR STAND. COMES WITH HEIGHT ADJUSTABLE FORKS FOR SPOOLS

→ STAND1MOTO-04

€ 49



**TAPIS SOL YCF 180X80 CM**  
YCF RUBBER MAT 180X80 CM ( 70in x 31 in )

→ TAPISSOL-3

€ 69



**TREPIED ACIER NOIR pour 50/88 - HAUTEUR 32 cm**  
50/88 STEEL BIKE STAND BLACK - HEIGHT 12 in.

→ TREPIED02-BK

€ 59



**TREPIED ACIER NOIR - HAUTEUR 40 cm**  
STEEL BIKE STAND BLACK - HEIGHT 15,7 in.

→ TREPIED01-BK

€ 59



**BÉQUILLE ROUE AR RÉGLABLE**  
ADJUSTABLE REAR WHEEL STAND

→ STAND1MOTO-02

€ 35

**TEXTILES  
APPAREL**



**PARAPLUIE YCF**  
YCF UMBRELLA

UMBRELLA

€ 29



**BONNET YCF**  
YCF BEANIE

→ BYCF01-BK

€ 15



**BENT CASQUETTE YCF ROUGE/BLANCHE**  
YCF RED/WHITE CURVED BILL HAT

→ CYCF03-RD

€ 19



**CASQUETTE BASEBALL YCF NOIRE/BLANCHE**  
YCF BLACK/WHITE SNAPBACK HAT

→ CYCF03-BK

€ 19



**SWEAT À CAPUCHE ZIPPÉ YCF (S/ M/ L/ XL/ XXL)**  
YCF ZIP HOODIE (SIZE: S/ M/ L/ XL/ XXL)

→ SWEAT02RD + TAILLE/ SIZE

€ 59



**CHEMISETTE RACING YCF (S/ M/ L/ XL/ XXL)**  
SHORT-SLEEVED RACING SHIRT (S/ M/ L/ XL/ XXL)

→ CHEMISETTE-2 + TAILLE/ SIZE

€ 35



**T-SHIRT YCF (TAILLE: S/ M/ L/ XL/ XXL)**  
YCF T-SHIRT (SIZE: S/ M/ L/ XL/ XXL)

→ TSYCFRD + TAILLE/ SIZE

€ 19



**T-SHIRT ENFANT YCF (TAILLE: 4 ANS/ 8 ANS)**  
YCF YOUTH T-SHIRT (SIZE: 4 YEARS/ 8 YEARS)

→ TSK02BL-4 (4 YEARS)  
→ TSK02BL-8 (8 YEARS)

€ 19

# GRAPHICS & PLASTICS



## ACCESSOIRES PLASTIQUES

KITS DÉCO/ GRAPHIC KITS	54
PERSONNALISATION/ CUSTOMIZATION	61
KITS PLASTIQUES/ PLASTIC KITS	62



**KIT DÉCO MONSTER (GAMME PILOT 2018-2021/ FACTORY 2017-2021)**  
MONSTER ENERGY® GRAPHIC KIT (RANGE PILOT 2018-2021/ FACTORY 2017-2021)

→ 20-90-106

€ 99



**KIT DÉCO GEICO (GAMME PILOT 2018-2021/ FACTORY 2017-2021)**  
GEICO® GRAPHIC KIT (RANGE PILOT 2018-2021/ FACTORY 2017-2021)

→ 20-90-107

€ 99



**KIT DÉCO STAR RACING (GAMME PILOT 2018-2021/ FACTORY 2017-2021)**  
STAR RACING GRAPHIC KIT (RANGE PILOT 2018-2021 /FACTORY 2017-2021)

→ 20-90-108

€ 99





**⚠ KIT COMPLET POUR GAMME 2007 À 2021**  
**COMPLETE KIT FOR RANGE 2007 TO 2021**



**KIT DÉCO GEICO®**  
 (GAMME START 2008-2019/ PILOT 2013-2015/ FACTORY 2012-2015)  
 GEICO® GRAPHIC KIT  
 (RANGE START 2008-2019/ PILOT 2013-2015/ FACTORY 2012-2015)

→ KD17-GEICO-01

€ 75



**KIT DÉCO MONSTER®**  
 (GAMME START 2008-2019/ PILOT 2013-2015/ FACTORY 2012-2015)  
 MONSTER ENERGY® GRAPHIC KIT  
 (RANGE START 2008-2019/ PILOT 2013-2015/ FACTORY 2012-2015)

→ KD17-MONSTER-01

€ 75



**KIT DÉCO DE CADRE POUR FACTORY**  
 GRAPHIC KIT FOR FACTORY FRAME

→ FGKFP-BK

€ 19



**KIT DÉCO GEICO® (GAMME PILOT 2016-2021/ FACTORY 2016-2018)**  
 GEICO® GRAPHIC KIT (RANGE PILOT 2016-2021/ FACTORY 2016-2018)

→ KD17-GEICO-02

€ 75



**KIT DÉCO MONSTER® (GAMME PILOT 2016-2021/ FACTORY 2016-2018)**  
 MONSTER ENERGY® GRAPHIC KIT (RANGE PILOT 2016-2021/ FACTORY 2016-2018)

→ KD17-MONSTER-02

€ 75



**KIT DÉCO DE CADRE POUR PILOT**  
 GRAPHIC KIT FOR PILOT FRAME

→ FGKP-BK

€ 16

**NEW  
2021**



# ORIGINAL YCF® KITS DÉCO/ GRAPHIC KITS



**KIT DÉCO 50 YCF 2021**  
50 YCF GRAPHIC KIT 2021

→ KD50A2021 (50 SEULEMENT/ ONLY) € 59



**KIT DÉCO LITE 88 2021**  
GRAPHIC KIT LITE 88 2021

→ KD88L2021 € 59



**KIT DÉCO LITE 125 2021**  
GRAPHIC KIT LITE 125 2021

→ KD125L2021 € 59



**KIT DÉCO START W88 2021**  
GRAPHIC KIT START W88E 2021

→ KD88E2021 € 59



**KIT DÉCO 50 YCF 2021**  
50 YCF GRAPHIC KIT 2021

→ KD50E2021 (50 SEULEMENT/ ONLY) € 59



**KIT DÉCO START 88SE 2021**  
GRAPHIC KIT START 88SE 2021

→ KD88SE2021 € 59



**KIT DÉCO START 125 2021**  
GRAPHIC KIT START 125 2021

→ KD1252021 € 59



**KIT DÉCO START 125SE 2021**  
GRAPHIC KIT START 125SE 2021

→ KD125SE2021 € 59



**KIT DÉCO PILOT 125 2021**  
GRAPHIC KIT PILOT 125 2021

→ KDP1252021

€ 59



**KIT DÉCO PILOT 150 2021**  
GRAPHIC KIT PILOT 150 2021

→ KDP1502021

€ 59



**KIT DÉCO SM 125 2021**  
GRAPHIC KIT SM 125 2021

→ KDSM1252021

€ 59



**KIT DÉCO FACTORY SP2 2021**  
GRAPHIC KIT FACTORY SP2 2021

→ KDSP22021

€ 59



**KIT DÉCO FACTORY SP3 190 2021**  
GRAPHIC KIT FACTORY SP3 190 2021

→ KDSP31902021

€ 59



**KIT DÉCO SM 150 2021**  
GRAPHIC KIT SM 150 2021

→ KDSM1502021

€ 59



**KIT DÉCO SM 190 2021**  
GRAPHIC KIT SM 190 2021

→ KDSM1902021

€ 59

**NEW  
2021**



**ORIGINAL YCF®  
KITS DÉCO/ GRAPHIC KITS**



**KIT DÉCO BIGY FACTORY 190 MX DAYTONA® 2021**  
GRAPHICS KIT BIGY FACTORY 190 MX DAYTONA® 2021

→ KDBIGYFD19021

€ 89



**KIT DÉCO BIGY 125 MX 2021**  
GRAPHICS KIT BIGY 125 MX 2021

→ KDBIGY12521

€ 89



**KIT DÉCO BIGY 150 MX 2021**  
GRAPHICS KIT BIGY 150 MX 2021

→ KDBIGY15021

€ 89

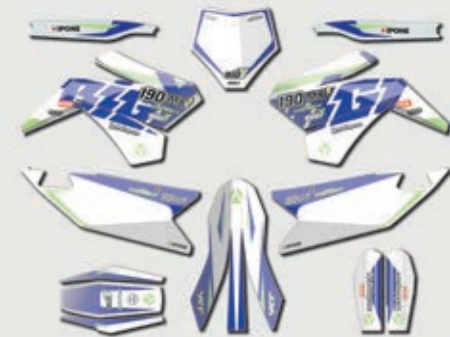

**KIT DÉCO BIGY FACTORY 190 MX ZE 2021**  
GRAPHICS KIT BIGY FACTORY 190 MX ZE 2021

→ KDBIGYFZE19021

€ 89





KIT DÉCO BIGY MONSTER  
BIGY MONSTER ENERGY® GRAPHIC KIT

→ 20-90-109

€ 119

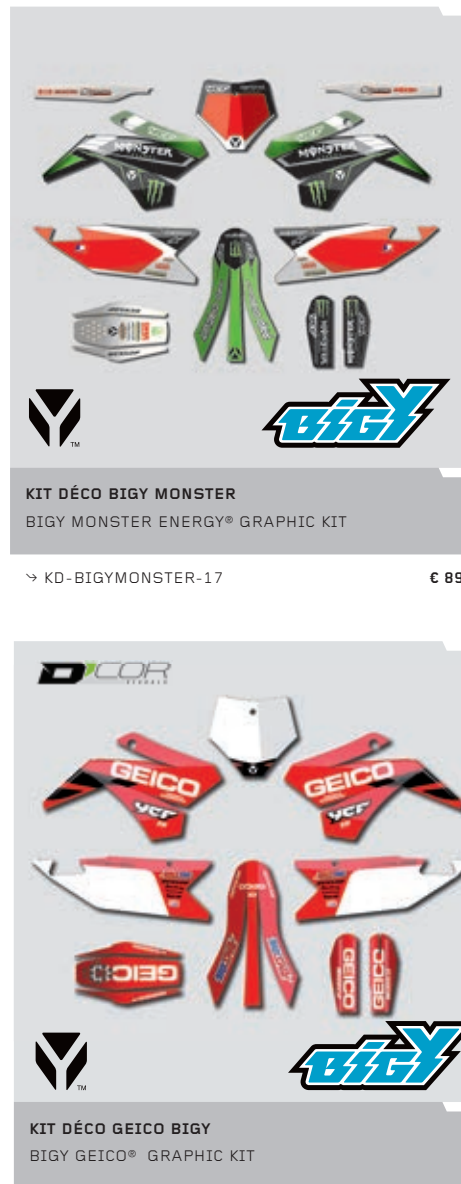

KIT DÉCO BIGY MONSTER  
BIGY MONSTER ENERGY® GRAPHIC KIT

→ KD-BIGYMONSTER-17

€ 89

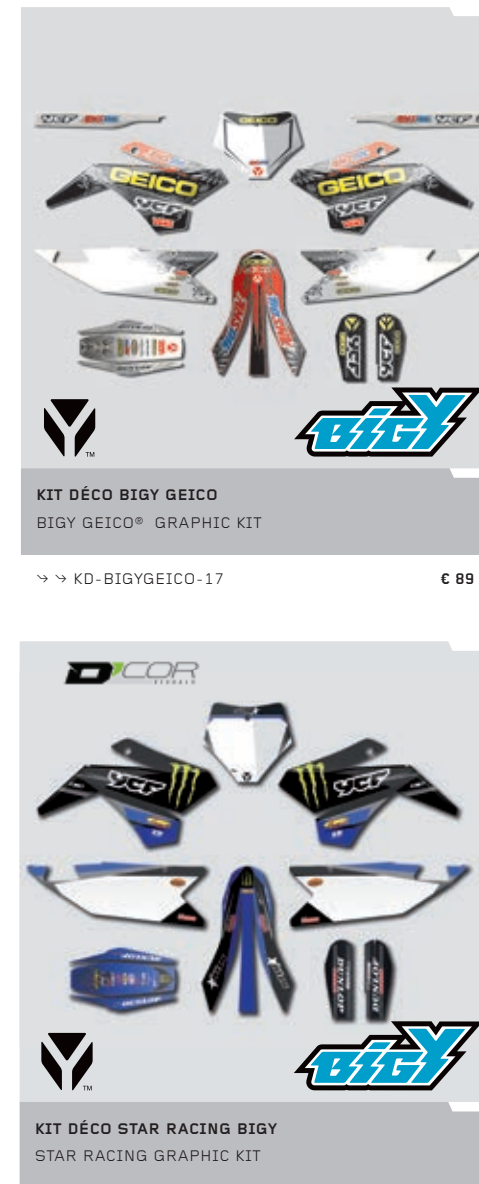

KIT DÉCO BIGY GEICO  
BIGY GEICO® GRAPHIC KIT

→ KD-BIGYGEICO-17

€ 89



KIT DÉCO GEICO BIGY  
BIGY GEICO® GRAPHIC KIT

→ 20-90-110

€ 119



KIT DÉCO STAR RACING BIGY  
STAR RACING GRAPHIC KIT

→ 20-90-111

€ 119



# PERSONNALISATION CUSTOMIZATION

## 31 968 COMBINAISONS

2 COULEURS DE PLAQUES (PLASTIQUE)  
8 COULEURS DE FONDS DE PLAQUES  
999 CHIFFRES (DESIGN YCF)  
2 COULEURS DE CHIFFRES

YCF ID 1,0 EST LA 1<sup>ÈRE</sup> ÉTAPE DU PROGRAMME DE PERSONNALISATION DE VOTRE MOTO YCF, VOUS POUVEZ MAINTENANT CRÉER VOTRE PLAQUE NUMÉRO ORIGINALE GRÂCE À UN LARGE CHOIX DE DESIGNS GRAPHIQUES ET DE COULEURS.

DISPONIBLE CHEZ VOTRE REVENDEUR.

## 31 968 COMBINATIONS

2 (PLASTIC) PLATE COLORS  
8 BACKGROUND PLATE COLORS  
999 INDIVIDUAL CHARACTERS (YCF DESIGN)  
2 COLORS AVAILABLE

YCF ID 1,0 IS THE FIRST STAGE OF THE CUSTOMIZATION PROCESS FOR YOUR YCF MINI-BIKE, YOU CAN NOW CREATE YOUR OWN ORIGINAL NUMBER PLATE THANKS TO A WIDE CHOICE OF GRAPHIC DESIGNS AND COLOR.

AVAILABLE AT YOUR RETAILER.



NUMÉRO POUR 3 PAR PLAQUE  
NUMBERS FOR 3 PER PLATE

01 → NUM./8CM (NOIR/ BLACK)  
01 → NUMW./8CM (BLANC/ WHITE) (x3) € 4

NUMÉRO POUR 2 PAR PLAQUE  
NUMBERS FOR 2 PER PLATE

02 → NUM./11CM (NOIR/ BLACK)  
02 → NUMW./11CM (BLANC/ WHITE) (x3) € 5

NUMÉRO POUR 1 PAR PLAQUE  
NUMBERS FOR 1 PER PLATE

03 → NUM./18CM (NOIR/ BLACK)  
03 → NUMW./18CM (BLANC/ WHITE) (x3) € 6



→ STSVYCF

€ 9



# KITS PLASTIQUES YCF YCF PLASTIC KITS



**NEW  
2021**



PLAQUE AVANT POUR LITE 88 2020-21/ LITE 125/ START 88SE 2020-21/ START 125/ PILOT/ FACTORY/ SM  
NOIRE/ ROSE/ ROUGE/ BLANCHE/ BLEUE/ VERTE/ JAUNE/ ORANGE/ GRIS

FRONT NUMBER PLATE FOR LITE 88 2020-21/ LITE 125/ START 88SE 2020-21/ START 125/ PILOT/ FACTORY/ SM  
BLACK/ PINK/ RED/ WHITE/ BLUE/ GREEN/ YELLOW/ ORANGE/ GREY

→ YC110-0212-07 + COLOR

€ 15

→ ANCIENNE RÉF : YC110-0212-02 + COLOR (LITE F88 - START F88 AVANT 2020)

€ 15



**NEW  
2021**



GARDE BOUE AVANT POUR LITE 125/ START 125/ PILOT/ FACTORY/ SM (2014-2021)/ START 88SE 2021  
NOIR/ ROSE/ ROUGE/ BLANC/ BLEU/ VERT/ JAUNE/ ORANGE/ GRIS

FRONT FENDER FOR LITE 125/ START 125/ PILOT/ FACTORY/ SM (2014-2021)/ START 88SE 2021  
BLACK/ PINK/ RED/ WHITE/ BLUE/ GREEN/ YELLOW/ ORANGE/ GREY

→ YC110-032-02 + COLOR

€ 15

→ ANCIENNE RÉF : YC110-032 + COLOR (LITE F88 - START F88 AVANT 2020)

€ 15





**OUIE RADIATEUR DROITE POUR LITE/ START 2007-2019/ PILOT 2007-17/ FACTORY 2007-16**  
**NOIRE/ ROUGE/ BLANCHE/ VERTE/ ORANGE**

RIGHT SHROUD FOR LITE/ START 2007-2019/ PILOT 2007-17/ FACTORY 2007-16  
 BLACK/ RED/ WHITE/ GREEN/ ORANGE

→ YC110-14-052 + COLOR

€ 15



**OUIE RADIATEUR GAUCHE POUR LITE/ START 2007-2019/ PILOT 2007-17/ FACTORY 2007-16**  
**NOIRE/ ROUGE/ BLANCHE/ VERTE/ ORANGE**

LEFT SHROUD FOR LITE/ START 2007-2019/ PILOT 2007-17/ FACTORY 2007-16  
 BLACK/ RED/ WHITE/ GREEN/ ORANGE

→ YC110-14-062 + COLOR

€ 15



**OUIE RADIATEUR DROITE EN 2 PARTIES POUR PILOT 2018-21/ FACTORY 2017-21/ START 2020-21**  
**NOIRE/ ROUGE/ BLANCHE/ VERTE/ JAUNE/ ORANGE/ GRIS/ BLEU**

RIGHT SHROUD 2 PARTS FOR PILOT 2018-21/ FACTORY 2017-21/ START 2020-21  
 BLACK/ PINK/ RED/ WHITE/ BLUE/ GREEN/ YELLOW/ ORANGE/ GREY/ BLUE

→ YC110-14-059 + COLOR

€ 19



**OUIE RADIATEUR GAUCHE EN 2 PARTIES POUR PILOT 2018-21/ FACTORY 2017-21/ START 2020-21**  
**NOIRE/ ROUGE/ BLANCHE/ VERTE/ JAUNE/ ORANGE/ GRIS/ BLEU**

LEFT SHROUD 2 PARTS FOR PILOT 2018-21/ FACTORY 2017-21/ START 2020-21  
 BLACK/ RED/ WHITE/ GREEN/ YELLOW/ ORANGE/ GREY/ BLUE

→ YC110-14-069 + COLOR

€ 19



**PLAQUE LATÉRALE DROITE POUR LITE/ START 2017-2021/ PILOT 2007-2015/ FACTORY 2007-2015  
NOIRE/ ROSE/ ROUGE/ BLANCHE/ BLEUE/ VERTE/ JAUNE/ ORANGE**

RIGHT NUMBER PLATE FOR LITE/ START 2017-2021/ PILOT 2007-2015/ FACTORY 2007-2015  
BLACK/ PINK/ RED/ WHITE/ BLUE/ GREEN/ YELLOW/ ORANGE

→ YC110-14-022 + COLOR

€ 15



**PLAQUE LATÉRALE GAUCHE POUR LITE/ START 2017-2021/ PILOT 2007-2015/ FACTORY 2007-2015  
NOIRE/ ROSE/ ROUGE/ BLANCHE/ BLEUE/ VERTE/ JAUNE/ ORANGE**

LEFT NUMBER PLATE FOR LITE/ START 2017-2021/ PILOT 2007-2015/ FACTORY 2007-2015  
BLACK/ PINK/ RED/ WHITE/ BLUE/ GREEN/ YELLOW/ ORANGE

→ YC110-14-042 + COLOR

€ 15



**PLAQUE LATÉRALE DROITE POUR PILOT 2016-21/ FACTORY 2016-21  
NOIRE/ ROUGE/ BLANCHE/ VERTE/ JAUNE/ ORANGE/ BLEU/ GRIS**

RIGHT NUMBER PLATE FOR PILOT 2016-21/ FACTORY 2016-21  
BLACK/ RED/ WHITE/ GREEN/ YELLOW/ ORANGE/ BLUE/ GREY

→ YC110-14-028 + COLOR

€ 15



**PLAQUE LATÉRALE GAUCHE POUR PILOT 2016-21/ FACTORY 2016-21  
NOIRE/ ROUGE/ BLANCHE/ VERTE/ JAUNE/ ORANGE/ BLEU/ GRIS**

LEFT NUMBER PLATE FOR PILOT 2016-21/ FACTORY 2016-21  
BLACK/ WHITE BLACK/ RED/ WHITE/ GREEN/ YELLOW/ ORANGE/ BLUE/ GREY

→ YC110-14-048 + COLOR

€ 15



**GARDE BOUE ARRIÈRE POUR LITE/ START 2007-2021/ PILOT 2007-2015/ FACTORY 2007-2015**  
**NOIR/ ROSE/ ROUGE/ BLANC/ BLEU/ VERT/ JAUNE/ ORANGE**  
 REAR FENDER FOR LITE/ START 2007-2021/ PILOT 2007-2015/ FACTORY 2007-2015  
 BLACK/ PINK/ RED/ WHITE/ BLUE/ GREEN/ YELLOW/ ORANGE

→ YC110-14-012 + COLOR

€ 15



**GARDE BOUE ARRIÈRE POUR PILOT 2016-21/ FACTORY 2016-21**  
**NOIR/ BLANC/ ROUGE/ VERT/ JAUNE/ ORANGE/ BLEU/ GRIS**  
 REAR FENDER FOR PILOT 2016-21/ FACTORY 2016-21  
 BLACK/ WHITE/ RED/ GREEN/ YELLOW/ ORANGE

→ YC110-14-018 + COLOR

€ 15



**PAIRE DE PROTECTIONS FOURCHE (ADAPTABLE SUR TOUTES LES FOURCHES)**  
**NOIRES/ VERTES/ ORANGES/ JAUNES/ BLANCHES/ ROUGES/ BLEUES**  
 PAIR OF FORK GUARD (WITH SLOTTED HOLE ADAPTABLE TO ALL FORKS)  
 BLACK/ GREEN/ ORANGE/ YELLOW/ WHITE/ RED/ BLUE

- 01 → PFYCF12 + COLOR (735mm)
- 01 → YC110-0418-01WH (BLANC/ WHITE - 660mm)
- 01 → YC110-0418-01BK (NOIR/ BLACK - 660mm)
- 02 → PFMARZO (NOIR/ BLACK)

€ 30  
 € 25



→ FOR 50 ONLY



**PAIRE DE PROTECTIONS FOURCHE POUR YCF 50 BLANCHE/ ROUGE/ JAUNE/ ORANGE/ VERTE/ BLEUE**  
 FORK GUARD FOR YCF 50 WHITE/ RED/ YELLOW/ ORANGE/ GREEN/ BLUE

→ YC50-0418 + COLOR

€ 19



NEW  
2021



GARDE BOUE AVANT YCF NOIR/ ROUGE/ BLANC/ VERT/ JAUNE/ ORANGE/ BLEU YCF/ BLEU/ GRIS  
YCF FRONT FENDER BLACK/ RED/ WHITE/ GREEN/ YELLOW/ ORANGE/ YCF BLUE/ BLUE/ GREY

→ YC110-032-10 + COLOR

€ 19



NEW  
2021



GARDE BOUE ARRIÈRE YCF NOIR/ ROUGE/ BLANC/ VERT/ JAUNE/ ORANGE/ BLEU/ GRIS  
YCF REAR FENDER BLACK/ RED/ WHITE/ GREEN/ YELLOW/ ORANGE/ BLUE/ GREY

→ YC110-14-019 + COLOR

€ 19



NEW  
2021



OUIE RADIATEUR YCF DROITE NOIRE/ ROUGE/ BLANCHE/ VERTE/ JAUNE/ ORANGE/ BLEU/ GRIS  
YCF RIGHT SHROUD 2 PARTS BLACK/ RED/ WHITE/ GREEN/ YELLOW/ ORANGE/ BLUE/ GREY

→ YC110-14-058 + COLOR

€ 19



NEW  
2021



OUIE RADIATEUR YCF GAUCHE NOIRE/ ROUGE/ BLANCHE/ VERTE/ JAUNE/ ORANGE/ BLEU/ GRIS  
YCF LEFT SHROUD 2 PARTS BLACK/ RED/ WHITE/ GREEN/ YELLOW/ ORANGE/ BLUE/ GREY

→ YC110-14-068 + COLOR

€ 19



PLAQUE AVANT YCF NOIRE/ ROUGE/ BLANCHE/ VERTE/ JAUNE/ ORANGE/ BLEUE YCF/ BLEU/ GRIS  
YCF FRONT NUMBER PLATE BLACK/ RED/ WHITE/ GREEN/ YELLOW/ ORANGE/ YCF BLUE/ BLUE/ GREY

→ YC110-0212-09 + COLOR

€ 19



PLAQUE LATÉRALE YCF DROITE NOIRE/ ROUGE/ BLANCHE/ VERTE/ JAUNE/ ORANGE/ BLEU/ GRIS  
YCF RIGHT NUMBER PLATE BLACK/ RED/ WHITE/ GREEN/ YELLOW/ ORANGE/ BLUE/ GREY

→ YC110-14-029 + COLOR

€ 19



PLAQUE LATÉRALE YCF GAUCHE NOIRE/ ROUGE/ BLANCHE/ VERTE/ JAUNE/ ORANGE/ BLEU/ GRIS  
YCF LEFT NUMBER PLATE BLACK/ RED/ WHITE/ GREEN/ YELLOW/ ORANGE/ BLUE/ GREY

→ YC110-14-049 + COLOR

€ 19



→ FOR 50 ONLY



**KIT PLASTIQUE YCF 50 BLANC/ NOIR/ ROUGE/  
JAUNE/ ORANGE/ VERT/ ROSE/ BLEU**  
YCF 50 PLASTIC KIT WHITE/ BLACK/ RED/ YELLOW/  
ORANGE/ GREEN/ PINK/ BLUE

→ KPYCF50-01 + COLOR

€ 60

**GARDE BOUE AVANT POUR YCF 50 ET LITE 88 2020  
BLANC/ NOIR/ ROUGE/ JAUNE/ ORANGE/ VERT  
ROSE/ BLEU**

FRONT FENDER FOR YCF 50 AND LITE 88 2020  
WHITE/ BLACK/ RED/ YELLOW/ ORANGE/ GREEN  
PINK/ BLUE

01 → YC50-031-01 + COLOR

€ 20

→ ANCIENNE RÉF : YC50-031 + COLOR  
(AVANT 2020)

€ 20



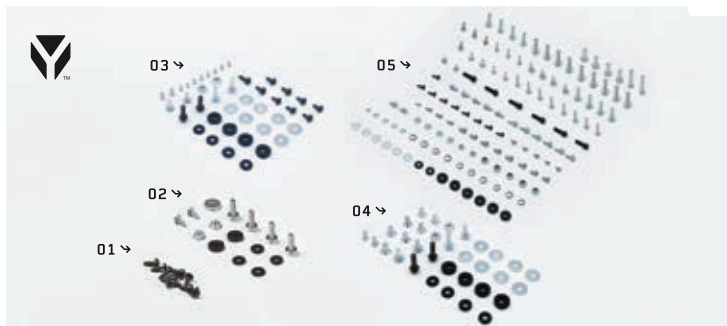

**KIT VIS POUR FIXER LES PLASTIQUES SUR LA SELLE**  
BOLT KIT FOR FIXING THE PLASTICS TO THE SEAT

01 → KVP € 2

**KIT VISSERIE POUR KIT PLASTIQUE (2+2 POUR RÉSERVOIR + 2 POUR SELLE SUR CADRE)**  
BOLT KIT FOR PLASTIC KIT (2+2 FOR FUEL TANK + 2 FOR SEAT ON FRAME)

02 → KVP-2 € 3

**KIT VISSERIE POUR PLASTIQUE START/ PILOT/ FACTORY**  
BOLT KIT FOR PLASTIC KIT START/ PILOT/ FACTORY

**NEW  
2021**

03 → KVP-3 € 6

**KIT VISSERIE POUR PLASTIQUE BIGY**  
BOLT KIT FOR PLASTIC KIT BIGY

**NEW  
2021**

04 → KVP-4 € 6

**KIT VIS COMPLET YCF**  
COMPLETE YCF BOLT KIT

**NEW  
2021**

05 → KVP-5 € 39



**PROTÈGE DISQUE AVANT BLEU/ ROUGE/ NOIR/ VERT/ ORANGE/ BLANC/ JAUNE**  
FRONT BRAKE PROTECTION BLUE/ RED/ BLACK/ GREEN/ ORANGE/ WHITE/ YELLOW

→ YC110-0627 + COLOR € 29



**NEW  
2021**

**PASSE DURITE FREIN AVANT CNC NOIR/ ORANGE/  
ROUGE/ VERT/ BLEU**  
OIL STEEL LINE RETAINER BLACK/ ORANGE/RED/  
GREEN/ BLUE/

→ YC110-0403-06 + COLOR € 15



**PASSE DURITE YCF**  
YCF BRAKE HOSE

01 → YC110-0403-05 € 2



**KIT RONDELLE CNC POUR RÉSERVOIR ET KIT PLAS-  
TIQUE, VENDU AVEC LES VIS BTR (2XM5/ 2XM6/ 1XM8)**  
NOIR/ ROUGE/ ORANGE/ VERT/ BLEU  
CNC WASHER AND BTR SCREW FOR TANK  
AND PLASTIC KIT (2XM5/ 2XM6/ 1XM8)  
BLACK/ RED/ ORANGE/ GREEN/ BLUE

→ KRV + COLOR € 19



**KIT COMPLET PHARES POUR START/ LITE/ FACTORY SP1 & SP2/ BIGY 125 & 150**  
LIGHT KIT FOR START/ LITE/ FACTORY SP1 & SP2/ BIGY 125 & 150

→ KL1E € 119  
→ KL1 € 159  
01 → YC110-1525-02 € 29



**PLAQUE PHARE AVANT YCF NOIRE/ BLANCHE**  
YCF HEADLIGHT BLACK/ WHITE

→ YC110-1523-02 + COLOR € 59

# FACTORY SP III

YCF FACTORY DAYTONA® 190 ANIMA  
RIDER : MIKE ALESSI  
TEAM : YCF USA





# MOTORCYCLE PARTS

## PIÈCES MOTO

<b>GUIDONS/ HANDLE BARS</b>	72
<b>POIGNÉES/ LEVERS</b>	74
<b>FOURCHES/ FORKS</b>	76
<b>CADRES/ FRAMES</b>	79
<b>SELLES/ SEATS</b>	80
<b>RÉSERVOIRS/ FUEL TANKS</b>	81
<b>FREINS/ BRAKES</b>	82
<b>BRAS OSCILLANTS/ SWING ARMS</b>	90
<b>AMORTISSEURS/ SHOCK ABSORBERS</b>	92
<b>ROUES/ WHEELS</b>	93
<b>JANTES &amp; MOYEUX/ RIMS &amp; HUBS</b>	93
<b>PNEUS/ TIRES</b>	100
<b>REPOSE-PIEDS &amp; SABOTS/ FOOT PEGS &amp; SKID PLATES</b>	102
<b>SÉLECTEURS/ SHIFT LEVERS</b>	103
<b>KITS CHAÎNES/ SPROCKET KITS</b>	104
<b>OUTILS/ TOOLS</b>	106
<b>ENGI®/ ENGI®</b>	108



# GUIDONS HANDLE BARS



**MOUSSE GUIDON SANS BARRE**  
NOIRE/ ROSE/ VERTE/ ROUGE/ ORANGE/ BLEUE/ JAUNE/ BLANCHE  
HANDLEBAR PAD WITHOUT CROSSBAR  
BLACK/ PINK/ GREEN/ RED/ ORANGE/ BLUE/ YELLOW/ WHITE

→ YC110-01046 + COLOR

€ 12



**MOUSSE GUIDON CAOUTCHOUC 3D**  
HANDLEBAR PAD WITH RUBBER COVER 3D

→ YC110-0133-01BK

€ 12



→ FOR 50 ONLY

**MOUSSE GUIDON YCF 50 SANS BARRE**  
NOIRE/ ROSE/ VERTE/ ROUGE/ ORANGE/ BLEUE/ JAUNE/ BLANCHE  
HANDLEBAR PAD YCF 50 WITHOUT CROSSBAR  
BLACK/ PINK/ GREEN/ RED/ ORANGE/ BLUE/ YELLOW/ WHITE

→ YC50-0129 + COLOR

€ 8



**MOUSSE GUIDON NOIRE/ ROSE/ VERTE/ ROUGE/ ORANGE/ BLEUE/ JAUNE/ BLANCHE**  
HANDLEBAR PAD BLACK/ PINK/ GREEN/ RED/ ORANGE/ BLUE/ YELLOW/ WHITE

→ YC110-0132 + COLOR

€ 8



**PAIRE DE PROTÈGES MAINS**  
HANDGUARD

→ YC110-14-070BK (NOIRE/ BLACK)  
→ YC110-14-070WH (BLANCHE/ WHITE)

€ 25



**PAIRE DE PROTÈGES MAINS ENDURO/SUPERMOTO**  
(FIXATION POUR GUIDON ACIER/ALU Ø 22,2 ET 28,6)  
ENDURO/SUPERMOTO HANDGUARDS  
(FIXING KITS FOR STEEL/ALU Ø 22,2 AND 28,6)

→ YC110-14-071BK (NOIRE/ BLACK)  
→ YC110-14-071WH (BLANCHE/ WHITE)

€ 59



**PROTÈGE LEVIER TYPE MOTOGP**  
MOTOGP STYLE LEVER PROTECTION

→ YC110-14-072BK

€ 39



**GUIDON ALUMINIUM (MOUSSE COMPRISE)**  
**BLEU/ ROUGE/ ORANGE/ VERT/ NOIR**  
 ALUMINIUM HANDLEBAR (BAR PAD INCLUDED)  
 BLUE/ BLACK/ RED/ ORANGE/ GREEN

→ GA + COLOR

€ 49



**GUIDON MID SIZE ALUMINIUM (MOUSSE COMPRISE)**  
**BLEU/ NOIR/ ROUGE/ ORANGE/ VERT**  
 ALUMINIUM CROSS BAR (BAR PAD INCLUDED)  
 BLUE BLUE/ BLACK/ RED/ ORANGE/ GREEN

→ GALOW + COLOR  
 → GALOW-03BK (BIGY)

€ 49



**GUIDON ALUMINIUM SANS BARRE (POUR YCF 50) BLEU/ NOIR/ ROUGE/ ORANGE/ VERT/ (MOUSSE COMPRISE)**  
 ALUMINIUM HANDLEBAR WITHOUT CROSSBAR (FOR YCF 50) BLUE/ BLACK/ RED/ ORANGE/ GREEN (BAR PAD INCLUDED)

01 → GASB50 + COLOR

€ 49

**GUIDON ALUMINIUM SANS BARRE BLEU/ NOIR/ ROUGE/ ORANGE/ VERT (MOUSSE COMPRISE)**

ALUMINIUM HANDLEBAR WITHOUT CROSSBAR BLUE/ BLACK/ RED/ ORANGE/ GREEN (BAR PAD INCLUDED)

02 → GASB + COLOR

€ 59

02 →

01 →



03 →

04 →

**GUIDON ACIER (POUR YCF 50)**  
 STEEL HANDLEBAR (FOR YCF 50)

**GUIDON CHROMOLLY**  
 CHROMOLLY HANDLEBAR

01 → YC50-0101-02 (YCF 50)  
 02 → YC110-0101-01 (CHROMOLLY)  
 03 → YC110-0101-12 (CHROMOLLY BAS/ LOW: 665mm)  
 04 → YC110-0101-16-BK (BIGY: 780mm)

€ 15



**GUIDON ALUMINIUM RENFORCÉ 28.6 mm**  
 ALUMINIUM HANDLEBAR 28.6 mm

→ GA-02BK (FACTORY 760mm)  
 → GALOW-04BK (BIGY 780mm)

€ 79  
 € 75



# POIGNÉES HANDLES



→ FOR 50 ONLY

**NEW  
2021**



01 →

02 →

**FACTORY**  
SPECIAL PARTS  
YCF RACING

**LEVIER DE FREIN AVANT OU ARRIÈRE PLIABLE POUR YCF 50 2020-21**  
NOIR/ BLEU/ ROUGE/ ORANGE/ VERT  
FOLDABLE FRONT OR REAR BRAKE LEVER FOR YCF 50 2020-21  
BLACK/ BLUE/ RED/ ORANGE/ GREEN

01 → LFG50-1 + COLOR (ARRIÈRE/ REAR) YCF50 2012-2019  
02 → LFD50-1 + COLOR (AVANT/ FRONT) YCF50 2012-2019

€ 35



**LEVIER D'EMBRAYAGE AVEC COCOTTE CNC NOIRE/ ROUGE/ BLEUE/ VERTE**  
CLUTCH LEVER WITH CNC BRACKET BLACK/ RED/ BLUE/ GREEN

→ YC110-0103-06 + COLOR

€ 129

**FACTORY**  
SPECIAL PARTS  
YCF RACING

**NEW  
2021**



01 →

02 →

**LEVIER DE FREIN OU D'EMBRAYAGE PLIABLE NOIR/ BLEU/ ROUGE/ ORANGE/ VERT**  
FOLDABLE BRAKE OR CLUTCH LEVER BLACK/ BLUE/ RED/ ORANGE/ GREEN

01 → LEP21+COLOR (EMBRAYAGE/ CLUTCH)  
02 → LFP21 + COLOR (FREIN/ BRAKE)

€ 35

€ 35



01 →

02 →

**LEVIER FREIN OU EMBRAYAGE REPLIABLE**  
VENDU AVEC LA COCOTTE

FOLDABLE BRAKE OR CLUTCH LEVER  
SOLD WITH BRACKET

01 → LEPLIABLE (EMBRAYAGE/ CLUTCH)  
02 → LFPLIABLE (FREIN/ BRAKE)

€ 28

€ 23



01 →

02 →

03 →

**POIGNÉE DE GAZ À TIRAGE RAPIDE YCF (VENDU AVEC LES 2 POIGNÉES)**

YCF QUICK-ACTION THROTTLE TUBE ( INCLUDE GRIP )

01 → YC110-0138-03

€ 19

**POIGNÉE DE GAZ AVEC RÉGLAGE (VIS DE BRIDAGE)**

THROTTLE TUBE WITH ADJUSTMENT SCREW ( POWER CONTROL )

02 → YC110-0138-04

€ 19

**VIS M5X50 POUR RÉGLAGE DE LA POIGNÉE DE GAZ**

SCREW FOR THROTTLE ADJUSTMENT, SIZE M5X50

03 → YC110-01022-06

€ 2



**LEVIER FREIN PLIABLE**  
FOLDABLE BRAKE LEVER

→ YC110-0517-01

€ 20



**LEVIER D'EMBRAYAGE + COCOTTE AVEC MOLETTE RAPIDE (2018-21)**

CLUTCH LEVER + BRACKET WITH FAST WRENCH ADJUSTER (2018-21)

→ YC110-0135-02

€ 23



**EMBOUIT PLASTIQUE DE GUIDON**  
BAR END CAPS

→ YC110-0153-01

€ 1



 → FOR 50 ONLY

**LEVIER FREIN COMPLET AVEC COCOTTE POUR YCF 50**  
BRAKE LEVER COMPLETE WITH BRACKET FOR YCF 50

→ YC50-0501 (AVANT/ FRONT) (YCF 50 2012-19)

→ YC50-01031 (ARRIÈRE/ REAR) (YCF 50 2012-19) € 10



**COCOTTE D'EMBRAYAGE**  
CLUTCH BRACKET

01 → YC110-0134-04 (2018-21)

€ 15

02 → YC110-0126-01 (YCF 2005-17)

€ 12

**CAOUTCHOUC DE LEVIER FREIN & EMBRAYAGE**  
RUBBER BRAKE & CLUTCH LEVERS

09 → YC110-0502-01 (FREIN/ BRAKE)

€ 3

10 → YC110-0103-10 (EMBRAYAGE/ CLUTCH)

**LEVIERS FREIN & EMBRAYAGE**  
BRAKE & CLUTCH LEVERS

04 → YC110-0103-07 (EMBR./ CLUTCH) (PILOT/ SM/ FACTORY/ BIGY 2018-21) €9

805 → YC110-0501-014 (FREIN/ BRAKE) (2005-17)

06 → YC110-0103-03 (EMBR./ CLUTCH) (2005-17) € 8

07 → YC50-0503-05 (FREIN AVANT/ FRONT BRAKE) (YCF 50 2020-21) € 8

08 → YC50-0503-06 (FREIN ARRIÈRE/ REAR BRAKE) (YCF 50 2020-21) € 8

**LEVIER FREIN RÉGLABLE POUR KIT FREIN 4 PISTONS**  
ADJUSTABLE BRAKE LEVER FOR 4 PISTONS BRAKE KIT

03 → YC110-0501-012

€ 8

 SPECIAL PARTS  
YCF RACING



**POIGNÉES CAOUTCHOUC YCF (X2)**  
GRISE/ ROSE/ ROUGE/ BLEUE/ BLANCHE/ JAUNE/  
VERTE/ NOIRE/ ORANGE

YCF RUBBER GRIPS (X2) GREY/ PINK/ RED/ BLUE/  
WHITE/ YELLOW/ GREEN/ BLACK/ ORANGE

→ PPC011 + COLOR

€ 10



**CÂBLE EMBRAYAGE**  
CLUTCH CABLE

01 → YC110-0107 L=900mm A+B=93mm (SM125 2021/ SM190 2021)

01 → YC110-0108 L=900mm A+B=65mm (SP1/ SM150)

01 → YC110-0109-21L=1000mm A+B=105mm (PILOT 150/ BIGY MX150)

01 → YC110-0109-22 L=1000mm A+B=93mm (SP3 190/ BIGY 190)

02 → YC110-0109-20 L=950mm A+B=75mm (LITE 125/ START 125/ BIGY 125MX)

02 → YC110-0109-23 L=920mm A+B=75mm (SP2) € 12



**DONUTS (X2) ROUGE/ JAUNE/ VERT/ ORANGE/ NOIR**  
GRIP DONUTS (X2) RED/ YELLOW/ GREEN/ ORANGE/ BLACK

→ DONUTZ-02 + COLOR

€ 4

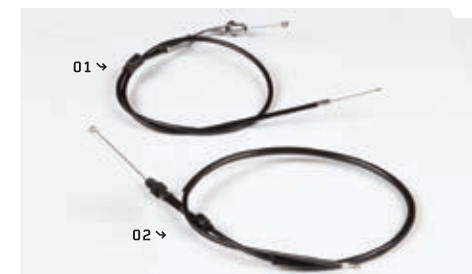

**CÂBLE DE GAZ**  
THROTTLE CABLE

01 → CGCOUDEE (CURVED OUTLET/ COUDÉ)

02 → YC110-0106 (ALL RANGE EXCEPT YCF50)

02 → YC50-0106-14 (FOR 50 ONLY)

02 → YC110-0106-12 (BIGY)

€ 12

# FOURCHES FORKS



**KIT RÉFÉCTION FOURCHE TAILLE 33/46/11 : 1 JOINT SPY/ 1 CACHE POUSSIÈRE/  
1 BAGUE INF/ 1 BAGUE SUP**  
FORK REPAIR KIT SIZE 33/46/11 INCLUDING: 1 FORK OIL SEAL/ 1 DUST COVER/  
1 LOWER RING/ 1 UPPER RING

→ YC110-0470

€ 16

**JOINT SPY FOURCHE**  
FORK OIL SEAL

01 → YC50-0415 (POUR/ FOR 50 - 25X25X10)  
01 → YC110-0440 ( 33\*46\*11 ) START/ PILOT/ FACTORY/ BIGY

€ 8



**JEU TUBE FOURCHE RÉGLABLE**  
ADJUSTABLE FORK

→ YC110-0400-10 (735mm)  
→ YC110-0400-35 (800mm)

€ 349



**JEU TUBE FOURCHE UPSD NON RÉGLABLE**  
UPSD FORK

→ YC110-0400-43 (600mm)  
→ YC110-0400-41 (660mm)  
→ YC110-0400-40 (735mm)  
→ YC110-0400-33 (800mm)

€ 179  
€ 189  
€ 189  
€ 199



**TÉ FOURCHE COMPLET 170MM SP3 48/48**  
TRIPLE CLAMP SET 48/48 170MM SP3

01 → YC110-0225-05-GY

€ 159



**BOUCHON PURGE DE FOURCHE Ø 5mm**  
NOIR/ BLEU/ ROUGE/ VERT/ ORANGE

FORK AIR BLEEDER Ø 5mm  
BLACK/ BLUE/ RED/ GREEN/ ORANGE

→ BPF1 + COLOR

€ 10



**TÉ FOURCHE COMPLET 160mm 48/45 OU 48/48 (ROUGE/ ORANGE/ BLEU/ VERT/ NOIR)**  
TRIPLE CLAMP SET 160mm 48/45 OR 48/48 (RED/ ORANGE/ BLUE/ GREEN/ BLACK)

- YC110-02-053 + COLOR (48/45)
- YC110-02-049 + COLOR (48/48)

€ 159  
€ 159

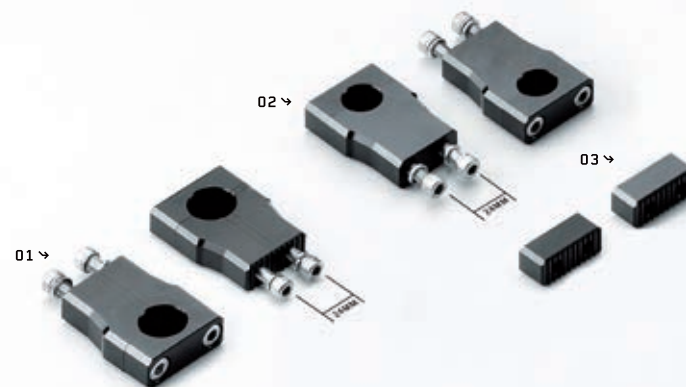

**JEU DE PONTETS GUIDON YCF 2012-2019**  
BAR MOUNTS FOR YCF 2012-2019

- 01 → YC110-0203-05 (LITE/ START/ PILOT/ SM/ BIGY MX) Ø 22,2 € 39
- 02 → YC110-0203-15 (SP3 2016-19/ BIGY 190 DAYTONA 2017-19) Ø 28,6 € 39
- 03 → YC110-0222-01 CALE POUR PONTET GUIDON ÉPAISSEUR 20mm (VENDU PAR PAIRE)  
(NON RÉGLABLE/ NOT ADJUSTABLE) € 5
- 03 → YC110-0222-02 CALE POUR PONTET GUIDON ÉPAISSEUR 20mm (VENDU PAR PAIRE) (RÉGLABLE/ ADJUSTABLE) € 10



**JEU DE PONTETS GUIDON YCF 2020-21**  
BAR MOUNT FOR YCF 2020-21

- 04 → YC110-0203-038 (FACTORY SP3/ BIGY 190 DAYTONA) Ø 28,6 € 59
- 05 → YC110-0203-035 (50/ LITE/ START/ PILOT/ SP2/ BIGY MX) Ø 22,2 € 49
- 06 → YC110-0222-03 CALE POUR PONTETS GUIDON € 10



**ÉCROU POUR COLONNE DE DIRECTION**  
STREERING STEM NUT

01 → YC110-02-09 (NOTCHED/ CRANTÉ)  
02 → YC110-02-11 (SUPÉRIEUR/ UPPER)

€ 5

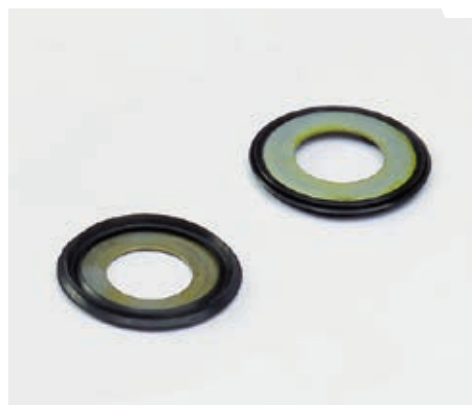

**JOINT POUR COLONNE DE DIRECTION ADAPTABLE**  
SUR START/ PILOT/ FACTORY/ SM/ BIGY

SEAL FOR STEERING STEM ADAPTABLE ON START/  
PILOT/ FACTORY/ SM/ BIGY

→ YC110-02-20

€ 3



**JEU DE ROULEMENT COLONNE DIRECTION**  
TAPER ROLLER BEARING FOR STEERING STEM

→ KRDIRIRECTION41, AFTERMARKET (INFÉRIEUR Ø EXT 41 - INT 23,5mm/ SUPÉRIEUR Ø EXT 41 - INT 22,5mm) € 29  
 → KRDIRIRECTION41-2, YCF50 2012-19 - START 88 2008-19 - LITE88/125 2016-19 (INFÉRIEUR Ø EXT 41 - INT 24mm/ SUPÉRIEUR Ø EXT 41 - INT 22,5mm) € 29  
 → KRDIRIRECTION46, ALL START 125 - PILOT - FACTORY - BIGY and 50A-E 2020-21 - START 88SE 2020-21 LITE 88-125 2020-21 (INFÉRIEUR Ø EXT 46 - INT 23,5mm/ SUPÉRIEUR Ø EXT 46 - INT 22mm) € 35



**ÉCROU POUR COLONNE DE DIRECTION NOIR/ BLEU/ ROUGE/ VERT/ ORANGE**  
STREERING STEM NUT BLACK/ BLUE/ RED/ GREEN/ ORANGE

→ ECD + COLOR

€ 12





# CADRES FRAMES



## BÉQUILLE STAND

- 01 → YC110-0904-01 (RÉGLABLE 250mm to 350mm) € 19  
01 → YC110-0904-05 (BIGY)

## RESSORT DE BÉQUILLE STAND'S SPRING

- 02 → YC110-19-01 € 2

## VIS ET ÉCROU BÉQUILLE STAND SCREW & NUT

- 03 → GB6170-M10-G (ÉCROU/ NUT) € 2  
04 → FB02-M10x1,5x30I (VIS/ SCREW)

## KIT VIS RENFORCÉE POUR MOTEUR ENGINE REINFORCED SCREW SET

- 05 → KITVIS8 (Ø 8) € 8  
05 → KITVIS10 (Ø 10)

## PATTE DE CADRE FRAME STEEL PADS

- YC110-16-061BK (START F125) € 15  
→ YC110-16-067BK (PILOT 2013) € 15  
→ YC110-1622-02BK (PILOT 2014-2020) € 15  
→ YC110-1622-03 (BIGY - SUNDAY) € 49



## CADRE BLANC RENFORCÉ 88 POUR BRAS MONO (BOUCLE ARRIÈRE INCLUSE) 88 REINFORCED WHITE FRAME FOR MONO SWING ARM (REAR SUBFRAME INCLUDED)

- YC88-161-0301-WH (START SE88) € 149



## BOUCLE ARRIÈRE 88 88 REAR SUBFRAME

- YC88-16-020 (START F88S) € 59  
→ YC88-16-022-BK (START F88SE)



## CADRE RENFORCÉ LITE POUR BRAS CANTILEVER (BOUCLE ARRIÈRE INCLUSE) LITE YCF REINFORCED FRAME FOR CANTILEVER SWING ARM (REAR SUBFRAME INCLUDED)

- YC110-161-0301-WH (LITE88) € 179  
→ YC110-161-0401-WH (LITE 125/ 150) € 179



## BOUCLE ARRIÈRE LITE LITE REAR SUBFRAME

- YC110-1614-13-BK (LITE F88) € 59  
→ YC110-1614-24-BK (LITE F125/ F150) € 59



## CADRE R START BLANC POUR BRAS MONO ET AMORTISSEUR 270mm (BOUCLE AR. INCLUSE) R START WHITE FRAME FOR MONO SWING ARM AND SHOCK ABSORBER 270mm (REAR SUBFRAME INCL.)

- YC110-166-0201-WH (START 125S) € 169



## BOUCLE ARRIÈRE START 125 START 125 REAR SUBFRAME PART

- YC110-16-070BK € 59



## CADRE COMPLET PILOT 125 & 150 2018-20 (AXE BRAS Ø 15) (BOUCLE ARRIÈRE INCLUSE) 2018-20 PILOT 125 & 150 COMPLET FRAME (ARM AXLE Ø 15) (REAR SUBFRAME INCLUDED)

- YC110-1621-0301-WH (BLANC/WHITE) (axe 15) € 239  
→ YC110-1601-0301-BK (NOIR/BLACK) (axe 15) € 239



## BOUCLE ARRIÈRE PILOT PILOT REAR SUBFRAME

- YC110-1614-26-BK (2016-21) € 79



## CADRE YCF 2019-2021 FACTORY (BOUCLE AR. INCLUSE) 2019-21 FACTORY YCF FRAME (REAR SUBFRAME INCL.)

- YC110-1621-0801-BK (CADRE 22° 2019-21) € 299



## BOUCLE ARRIÈRE FACTORY FACTORY REAR SUBFRAME

- YC110-1614-15-BK (2016-21 ACIER/ STEEL) € 79  
→ YC110-1614-18 (2016-21 ALUMINIUM) € 79



## CADRE YCF 2018-21 BIGY (AXE BRAS Ø 15) (BOUCLE ARRIÈRE INCLUSE) 2018-21 BIGY YCF FRAME (ARM AXLE Ø 15) (REAR SUBFRAME INCLUDED)

- YC110-1621-0201-BK (COMPLET) € 299



## BOUCLE ARRIÈRE BIGY BIGY REAR SUBFRAME

- YC110-1614-08-BK (ACIER/ STEEL) € 99  
→ YC110-1614-09-BK (190ZE) € 109

# SELLES & HOUSSES SEATS & COVERS

**FACTORY**  
SPECIAL PARTS  
YCF RACING



**SELLE COMPLÈTE ANTI DÉRAPANTE RENFORCÉE BLEUE/ ROUGE/ VERTE/ JAUNE/ ORANGE**  
COMPLETE NON-SLIP REINFORCED SEAT BLUE/ RED/ GREEN/ YELLOW/ ORANGE

→ YC110-1401-12 + COLOR (BIGY)

€ 89

**FACTORY**  
SPECIAL PARTS  
YCF RACING



**SELLE COMPLÈTE ANTI DÉRAPANTE RENFORCÉE BLEUE/ ROUGE/ VERTE/ JAUNE/ ORANGE**  
COMPLETE NON-SLIP REINFORCED SEAT BLUE/ RED/ GREEN/ YELLOW/ ORANGE

→ YC110-1401-08 + COLOR ( LITE 2016-21, START 2009-21, PILOT 125 2013-14)  
→ YC110-1401-07 + COLOR (PILOT 125 2015-21, PILOT 150, FACTORY, SM 150)

€ 69

€ 89



**SELLE YCF POUR BIGY**  
YCF SEAT FOR BIGY

→ YC110-1401-11

€ 69

**FACTORY**  
SPECIAL PARTS  
YCF RACING



**SELLE YCF LONGUE PILOT 125 2015-21/ PILOT 150 2013-21/ FACTORY 2012-21/ SM 150 2013-21/ SM 190 2021**

YCF LONG SEAT PILOT 125 2015-21/ PILOT 150 2013-21/ FACTORY 2012-21/ SM 150 2013-21/ SM 190 2021

→ YC110-1401-17

€ 69

→ FOR 50 ONLY



01 →



02 →



**SELLE YCF 50**  
YCF 50 SEAT

01 → YC50-1401-05

€ 39

02 → YC50-1401-03 (HAUTE/ HIGH + 4 cm)

€ 39



**SELLE LITE 2016-21/ START 2009-21/ PILOT 125 2013-14**

SEAT LITE 2016-21/ START 2009-21/ PILOT 125 2013-14

→ YC110-1401-10

€ 49



**SELLE BASSE YCF POUR LITE 2016-21/ START 2009-21/ PILOT 125 2013-14**

YCF LOW SEAT FOR LITE 2016-21/ START 2009-21/ PILOT 125 2013-14

→ YC110-14013

€ 49

→ FOR 50 ONLY



**SELLE COMPLÈTE ANTI DÉRAPANTE RENFORCÉE BLEUE/ ROUGE/ VERTE/ JAUNE/ ORANGE**  
COMPLETE NON-SLIP REINFORCED SEAT BLUE/ RED/ GREEN/ YELLOW/ ORANGE

→ YC50-1401+ COLOR (50 SEULEMENT/ ONLY)

€ 49

# RÉSERVOIRS FUEL TANKS



**RÉSERVOIR ET COUVRE RÉSERVOIR YCF POUR BIGY**  
YCF FUEL TANK AND TANK COVER FOR BIGY

01 → YC110-0701-04  
02 → YC110-0719-01

€ 59  
€ 15



**RÉSERVOIR YCF (ADAPTABLE SUR TOUTES LES ANCIENNES YCF ET SUR LES MINIS AVEC RÉSERVOIR TYPE CRF 50)**  
YCF FUEL TANK (CAN BE ADAPTED TO ALL PREVIOUS YCF AND TO MINI-BIKES WITH A TYPE CRF 50 FUEL TANK)

→ YC110-0701-01

€ 39



**RÉSERVOIR POUR YCF 50**  
FUEL TANK FOR YCF 50

→ YC50-07012

€ 39



**BOUCHON RÉSERVOIR ALUMINIUM YCF NOIR/ ROUGE/ ORANGE/ VERT/ BLEU**  
YCF ALUMINIUM GAS CAP BLACK/ RED/ ORANGE/ GREEN/ BLUE

→ BOUCHONALU+ COLOR

€ 35



**VALVE PRISE AIR BLEUE/ NOIRE/ ROUGE/ ORANGE/ VERTE**  
FUEL VENT VALVE BLUE/ BLACK/ RED/ ORANGE/ GREEN

→ YC125-0704 + COLOR

€ 9



**DURITE ESSENCE ROUGE/ ORANGE/ BLEUE/ VERTE/ JAUNE/ ROSE**

FUEL LINE RED/ ORANGE/ BLUE/ GREEN/ YELLOW/ PINK

→ DC + COLOR

€ 6

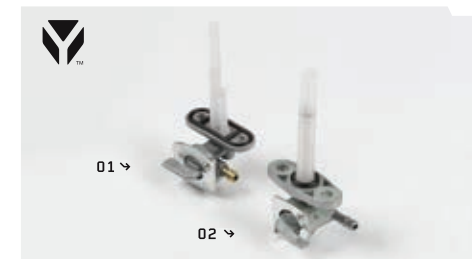

01 →

02 →

**ROBINET ESSENCE**  
FUEL PETCOCK

02 → YC110-0703 (1 EXIT FOR YCF/ 1 SORTIE POUR YCF)  
01 → 13020100 (2 EXITS/ 2 SORTIES)

€ 25

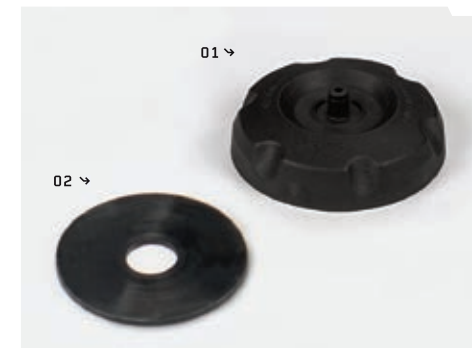

01 →

02 →

**BOUCHON ET JOINT RÉSERVOIR PLASTIQUE**  
GAS CAP AND SEAL

01 → YC110-0702-01 (YCF ORIGINAL DESIGN)

02 → YC110-0720-02

€ 13

€ 2

# FREINS BRAKES



**PATTE DE FREIN CNC POUR ÉTRIER RADIAL**  
CNC ALUMINIUM BRACKET FOR RADIAL BRAKE CALIPER

01 → YC110-0510-06-SI (AV./FR. FOR DISK 220 MM)  
01 → YC110-0510-07-SI (AV./FR. FOR DISK 240 MM)  
02 → YC110-1210-06-SI (ARR./ REAR) **€ 39**

**RESSORT ANTI VIBRATION  
POUR ÉTRIER RADIAL ARRIÈRE**  
REAR SPRING ANTI VIBRATION  
FOR REAR CNC RADIAL BRAKE

03 → YC110-1256-02 **€ 5**

**RESSORT PLAQUETTE DE FREIN  
POUR ÉTRIER RADIAL AVANT**  
BRAKE PADS SPRING FOR FRONT CNC RADIAL BRAKE

04 → YC110-0556-02 **€ 5**

**AXE DE PLAQUETTE DE FREIN POUR ÉTRIER RADIAL**  
BRAKE PADS AXLE FOR CNC RADIAL BRAKE

05 → YC110-0555-02 (AVANT/ FRONT) **€ 4**  
06 → YC110-1255-02 (ARRIÈRE/ REAR) **€ 4**



**KIT FREIN AVANT RADIAL**  
RADIAL FRONT BRAKE KIT

→ YC110-05012-09BK **€ 149**



**KIT FREIN ARRIÈRE RADIAL**  
RADIAL REAR BRAKE ASSEMBLY

→ YC110-12012-0BK **€ 149**



**MAÎTRE CYLINDRE FREIN AVANT SUPERMOTARD**  
SUPERMOTARD FRONT BRAKE MASTER CYLINDER

→ YC110-0507-01 **€ 99**



**LEVIER FREIN SEUL POUR MAÎTRE CYLINDRE FREIN AVANT SM**  
SM BRAKE LEVER FOR FRONT BRAKE MASTER CYLINDER

→ YC110-0503-02 **€ 30**



**ÉTRIER FREIN CNC RADIAL FACTORY**  
FACTORY BRAKE CALIPER RADIAL CNC

01 → YC110-1201-06-BK (ARRIÈRE/ REAR) **€ 115**  
02 → YC110-0502-06-BK (AVANT/ FRONT)



**KIT FREIN AVANT FACTORY (LEVIER RÉGLABLE) 2016-21**  
**FACTORY FRONT BRAKE KIT (AJUSTABLE LEVER) 2016-21**

→ YC110-0501-3101 (SP2/ SP3/ BIGY) € 90



**KIT FREIN ARRIÈRE FACTORY 2016-2021**  
**FACTORY REAR BRAKE ASSEMBLY 2016-2021**

→ YC110-12012-2601 (SP2/ SP3)  
 → YC110-12012-2801 (BIGY FACTORY) € 90



**KIT FREIN ARRIÈRE HYDRAULIQUE YCF 50 2020-21 (ADAPTABLE SUR LES YCF 50 2012-2019)**  
**HYDRAULIC REAR BRAKE KIT YCF 50 2020-21 (CAN FIT ON YCF 50 2012-2019)**

→ YC50-1214-03 € 79



**KIT FREIN AVANT HYDRAULIQUE YCF 50 2020-21 (ADAPTABLE SUR LES YCF 50 2012-2019)**  
**HYDRAULIC FRONT BRAKE KIT YCF 50 2020-21 (can fit on YCF 50 2012-2019)**

→ YC50-0511-03 € 79





**ÉTRIER FREIN AVANT**  
FRONT BRAKE CALIPER

- 01 → YC110-0501-0205 (DOUBLE PISTON) € 59
- 02 → YC110-0501-0203 (4 PISTONS) € 59
- 03 → YC50-0502 (YCF 50) € 39
- 08 → YC110-0501-0207 (SP3 2016-21) € 69

**MAITRE CYLINDRE AVANT**  
FRONT BRAKE MASTER CYLINDER

- 04 → YC110-0501-0103 (FREINAGE À GAUCHE) € 49
- 04 → YC110-0501-0102 (DOUBLE PISTON) € 49
- 05 → YC110-0501-0101 (4 PISTONS) € 49
- 07 → YC110-0501-0104-01 (PILOT/ FACTORY 2016-21) € 59

**DURITE FREIN AVANT**  
FRONT BRAKE HOSE

- 06 → YC110-0501-0325 (FILETAGE AU MAÎTRE CYLINDRE) € 29
- 06 → YC110-0501-0327 (BANJO AU MAÎTRE CYLINDRE/ BIGY)



**KIT FREIN COMPLET AVANT AVEC ÉTRIER DOUBLE PISTON**  
COMPLETE FRONT BRAKE KIT WITH DOUBLE PISTON CALIPER

- YC110-0501-1801 (LITE F125/F150, START F125, SP)
- YC110-0501-3301 (BIGY/ PILOT/ SM F150)

€ 75



**KIT FREIN AVANT COMPLET START F88 2010/2019**  
COMPLETE FRONT BRAKE KIT START F88 2010/2019

- YC110-0501-2001

€ 75



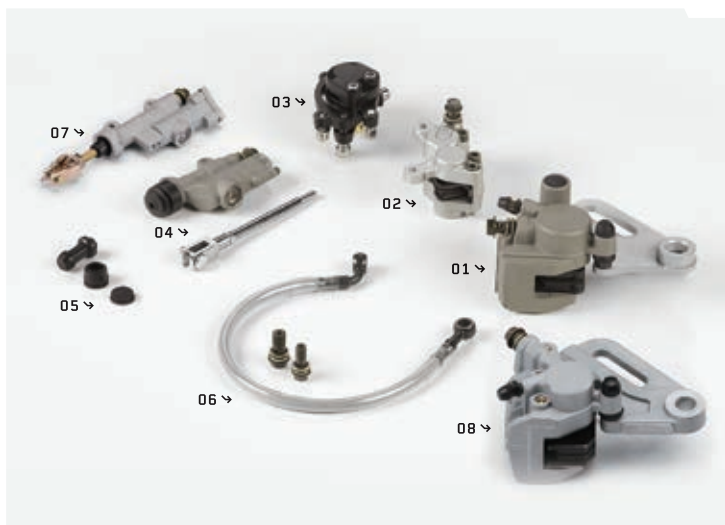

**ÉTRIER FREIN ARRIÈRE**  
REAR BRAKE CALIPER

- 01 → YC110-1201-0401 (1 PISTON) € 59
- 02 → YC110-0501-0203 (4 PISTONS) € 39
- 03 → YC50-1201 (YCF 50) € 69
- 08 → YC110-1201-07 (SP3 2016-21)

**MAÎTRE CYLINDRE FREIN ARRIÈRE**  
REAR BRAKE MASTER CYLINDER

- 04 → YC110-1201021 (Ø 8/ DIST. 40mm) € 30
- YC110-1201023 (Ø 10/ DIST. 40mm) € 30
- 07 → YC110-1201025 (Ø 10/ DIST. 53mm) € 39
- YC110-1201026 (Ø 10/ LITE) € 30

**JEU DE CAOUTCHOUCS ÉTRIER FREIN ARRIÈRE**  
SET OF REAR BRAKE CALIPER RUBBER

- 05 → YC110-120110 € 5

**DURITE FREIN ARRIÈRE Ø 10 ÉTRIER**  
REAR BRAKE HOSE CONNECTION Ø 10 CALIPER

- 06 → YC110-1201045 (Ø 8 MASTER CYLINDER) 370mm
- 06 → YC110-1201041 (Ø 8 MASTER CYLINDER) 465mm
- 06 → YC110-1201038 (Ø 10/ LITE) 410mm
- 06 → YC110-1201048 (Ø 10/ PILOT/ SP1 2016-21) 465mm
- 06 → YC110-1201050 (Ø 10/ SP2/ SP3 2016-21) 465mm
- 06 → YC110-1201049 (Ø 10/ BIGY) 515mm € 19



**KIT FREIN COMPLET ARRIÈRE 1 PISTON**  
COMPLETE REAR BRAKE ASSEMBLY

- YC110-12012-0601 (START) € 75
- YC110-12012-3101 (LITE) € 75
- YC110-12012-2701 (BIGY) € 75
- YC110-12013-0301 (360 mm START 88SE 2020-21) € 75
- YC110-12012-2401 (PILOT/ SM F150) € 75



**MAÎTRE CYLINDRE AVEC BOCAL**  
MASTER CYLINDER WITH BOWL

- YC110-120102 € 35





**FACTORY**

**PÉDALE DE FREIN FACTORY AVEC ROULEMENT**  
FACTORY BRAKE PEDAL WITH BEARING

→ YC110-219-03

€ 39



**NEW  
2021**

**FACTORY**

**PÉDALE FREIN FACTORY AVEC ROULEMENT NOIR**  
BLACK FACTORY BRAKE PEDAL WITH BEARING

→ YC110-219-03-BK

€ 39



**NEW  
2021**

**EMBOUT PEDALE FREIN ALUMINIUM BLEU/ ROUGE/  
NOIR/ ORANGE/ VERT**

COLOR REAR BRAKE LEVER TIPS BLUE/ RED/ BLACK/  
ORANGE/ GREEN

→ YC110-1223-02-COLOR

€ 6



**PROTECTION MAÎTRE CYLINDRE FREIN ARRIÈRE  
POUR LITE/ START 2007-21/ PILOT/ FACTORY 2007-15**  
REAR BRAKE MASTER CYLINDER GUARD  
FOR LITE/ START 2007-21/ PILOT/ FACTORY 2007-15

→ YC110-1224

€ 12



**START**

**PÉDALE FREIN ALUMINIUM POUR 88/125 START**  
ALUMINIUM BRAKE PEDAL FOR 88/125 START

→ YC110-218

€ 39



**START**

**PÉDALE FREIN ACIER POUR START 88/125**  
STEEL BRAKE PEDAL FOR 88/125 START

→ YC110-211

€ 25



**PÉDALE DE FREIN ACIER**  
STEEL BRAKE PEDAL

→ YC110-217 (R-START/ PILOT 140 2010-11-12)

→ YC110-217-02 (PILOT/ SM150 2013-21)

€ 25



→ FOR 50 ONLY



**KIT PÉDALE FREIN AU PIED POUR YCF 50 2012-19**  
BRAKE PEDAL KIT FOR YCF 50 2012-19

→ YC50-1219

€ 49



**PÉDALE DE FREIN ALUMINIUM HAUT DE GAMME  
2010-2011-CLASSIC 2012**  
ALUMINIUM BRAKE PEDAL HIGH-RANGE  
2010-2011-CLASSIC 2012

→ YC110-215

€ 39



**CHAPE MAÎTRE CYLINDRE FREIN ARRIÈRE CNC  
BLEU/ NOIR/ ROUGE/ ORANGE/ VERT**  
CNC REAR BRAKE CLEVIS BLUE/ BLACK/ RED/  
ORANGE/ GREEN

→ EMC + COLOR

→ EMC01 + COLOR (PILOT/ FACTORY/ BIGY 2016-21)

€ 15



**EMBOUT PÉDALE FREIN**  
REAR BRAKE LEVER TIPS

01 → YC110-1223-01 (ACIER/ STEEL)

€ 5

02 → YC110-1223-02 (ALUMINIUM)

€ 10

**CÂBLE DE PÉDALE DE FREIN ARRIÈRE AVEC GAINÉ  
(POUR ÉVITER DE TORDRE LA PÉDALE DE FREIN)**  
REAR BRAKE PEDAL CABLE WITH SHEATH  
(TO AVOID BRAKE PEDAL TWISTING)

03 → YC110-1260-01

€ 5

**RESSORT PÉDALE FREIN**  
BRAKE PEDAL SPRING

04 → YC110-21-01 (ACIER/ STEEL)

04 → YC110-21-05 (ALUMINIUM)

04 → YC110-21-06 (ALUMINIUM FACTORY)

€ 5





SPECIAL PARTS  
YCF RACING



# FACTORY

01 ↘	PPC011-WH	€ 10
02 ↘	LFP21-BK	€ 25
03 ↘	DONUTZ-02-GR	€ 4
04 ↘	YC110-0103-06-GR	€ 129
05 ↘	DC-GR	€ 5
06 ↘	BOUCHOUALU-BK	€ 35
07 ↘	KD-BIGYMONSTER-17	€ 89
08 ↘	YC110-140-02-BK	€ 399
09 ↘	YC110-2303	€ 95
10 ↘	YC110-0404-69	€ 299
11 ↘	RPALU-GR	€ 69
12 ↘	TC12-GR	€ 19



**DISQUE DE FREIN ENTRAXE 102,5mm Ø INT. 76mm**  
BRAKE DISC CENTRE TO CENTRE DISTANCE 102,5mm  
INNER Ø 76mm

- YC110-0513-02 (AVANT/ FRONT 220mm) € 35
- YC110-1115-01 (ARRIÈRE/ REAR 200mm) € 35
- YC110-1115-06 (220mm PERCÉ EN 10mm) € 35
- YC110-1115-07 (220mm PERCÉ EN 10mm) € 39



**KIT VIS INOX POUR DISQUE DE FREIN**  
INOX BOLT KIT FOR BRAKE DISC

- KVD € 3



**DISQUE DE FREIN AVANT 240mm AVEC PATTE DE DÉPORT**  
240mm FRONT BRAKE DISC WITH LEG OFFSET

- KS2 € 49

**NEW 2021**



**DISQUE FREIN AVANT FLOTTANT 220mm**  
SEMI FLOATING BRAKE ROTOR

- YC110-0613-01-BK € 99

**NEW 2021**



**DISQUE DE FREIN AVANT FLOTTANT 240mm**  
AVEC PATTES DE DÉPORT  
240mm SEMI FLOATING BRAKE ROTOR WITH CALIPER  
MOUNTING BRACKETS KIT

- KS2-1 € 129

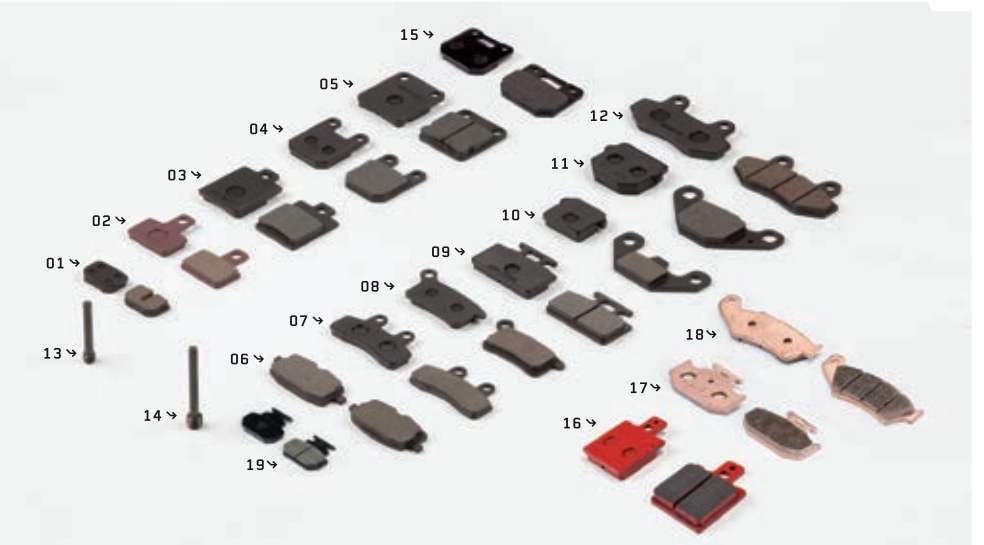

**JEU DE PLAQUETTES FREIN AV. & AR. POUR YCF 50**  
SET OF BRAKE PADS FRONT & REAR FOR YCF 50

- 01 → YC50-0506 (2012-2019) € 17
- 19 → YC50-0506-02 (YCF 50 2020-21 HYDRAULIQUE) € 19

**JEU DE PLAQUETTES FREIN ARRIÈRE**  
REAR BRAKE PADS

- 02 → YC110-120107
- 03 → YC110-120108
- 04 → 14030213/4N (YCF 2005)
- 17 → YC110-1204-02 (SP 2016-21/ BIGY/  
FACTORY 2017-20) € 17

**JEU DE PLAQUETTES FREIN AR. 1 PISTON YCF**  
REAR BRAKE PADS SINGLE 1 PISTON YCF

- 05 → YC110-120104 (START 2012-21/ LITE 2016-20) € 17

**JEU DE PLAQUETTES FREIN AVANT YCF 2005**  
FRONT BRAKE PADS YCF 2005

- 06 → 14010114/5 € 17

**JEU DE PLAQUETTES FREIN AVANT/ARRIÈRE POUR**  
ÉTRIER 4 PISTONS POUR YCF 2007 ET 88 2009-11  
BRAKE PADS FRONT/REAR FOR 4 PISTONS CALIPER  
FOR YCF 2007 AND 88 2009-11

- 08 → YC110-0501-0401 € 17

**JEU DE PLAQUETTES FREIN AVANT**  
FRONT BRAKE PADS

- 07 → YC110-0501-0405
- 09 → YC110-0501-0404
- 10 → YC110-0501-0406
- 18 → YC110-0501-0416 (SP 2016-21/ BIGY/  
FACTORY 2017-20) € 17

**JEU DE PLAQUETTES SIMPLE PISTON POUR YCF 2006**  
BRAKE PADS SINGLE PISTON FOR YCF 2006

- 11 → YC110-0501-0402 € 17

**JEU DE PLAQUETTES FREIN AVANT YCF 2008-13**  
FRONT BRAKE PADS YCF 2008-13

- 12 → YC110-0501-0403 € 17

**VIS PLAQUETTE FREIN AVANT OU ARRIÈRE**  
FRONT OR REAR BRAKE PADS SCREW

- 13 → YC110-1255 (ARRIÈRE/ REAR)
- 14 → YC110-0555 (AVANT/ FRONT) € 2

**JEU DE PLAQUETTES FREIN RADIAL AV. & AR.**  
SET OF RADIAL BRAKE PADS FRONT & REAR

- 15 → YC110-0506-01 (AVANT/ FRONT)
- 16 → YC110-1204-01 (ARRIÈRE/ REAR) € 17



**FACTORY**  
SPECIAL PARTS  
YCF RACING

**CAPOT MAÎTRE CYLINDRE FREIN AVANT CNC**  
BLEU/ NOIR/ ROUGE/ ORANGE/ VERT  
FRONT BRAKE RESERVOIR COVER BLUE/ BLACK/ RED/ ORANGE/ GREEN

→ FBRC + COLOR (ALL YCF MODELS EXCEPT PILOT/ FACTORY 2016-2021)  
→ FBRC01 + COLOR (PILOT/ FACTORY/ BIGY 2016-21)

€ 15



**FACTORY**  
SPECIAL PARTS  
YCF RACING

**CAPOT MAÎTRE CYLINDRE FREIN ARRIÈRE CNC**  
BLEU/ NOIR/ ROUGE/ ORANGE/ VERT  
REAR BRAKE RESERVOIR COVER BLUE/ BLACK/ RED/ ORANGE/ GREEN

→ RBRC + COLOR (ALL YCF MODELS EXCEPT PILOT/ FACTORY 2016-2021)  
→ RBRC01 + COLOR (PILOT/ FACTORY/ BIGY 2016-21)

€ 12

# BRAS OSCILLANTS SWING ARMS



**NEW  
2021**

**DIABOLO CNC NOIR/ BLEU/ ROUGE / VERT/ ORANGE**  
CNC REAR SPOOL BLACK/ BLUE/ RED/ GREEN/ ORANGE

→ KRS-COLOR

€ 17



**FACTORY**  
SPECIAL PARTS  
YCF RACING

**BRAS OSCILLANT MONO ALU RENFORCÉ**  
ALUMINIUM REINFORCED MONO SWING ARM

- YC110-10015-01 (420mm POUR/ FOR SP2 2014-2021/ SP3 2014-21)
- YC110-1001-2101 (460mm POUR/ FOR SP3 2019-21)
- YC110-1001-10 (460mm, AXE 12 POUR/ FOR BIGY 2017)
- YC110-1001-1601 (460mm, AXE 15 POUR/ FOR BIGY 2018-21)

€ 229



**BRAS OSCILLANT MONO CHROMOLY START**  
START MONO CHROMOLY SWING ARM

- YC110-1001-0701 (350mm)
- YC110-10014-01 (390mm)

€ 99



**BRAS OSCILLANT MONO CHROMOLY**  
CHROMOLY MONO SWING ARM

- YC110-1001-05 (420mm, AXE 12 POUR/ FOR PILOT 2015-17)
- YC110-1001-1701 (420mm, AXE 15 POUR/ FOR PILOT 2018-21)
- YC110-1001-09 (460mm, AXE 12 POUR/ FOR BIGY 2017)
- YC110-1001-1501 (460mm, AXE 15 POUR/ FOR BIGY 2018-21)
- YC110-1001-08 (420mm, AXE 12 POUR SPI)

€ 139



**BRAS OSCILLANT CANTILEVER LITE**  
LITE CANTILEVER SWING ARM

- YC110-1001-1201

€ 89



**PROTÈGE DISQUE ARRIÈRE RENFORCÉ NYLON**  
REINFORCED NYLON REAR DISC GUARD

→ YC110-1024-04

€ 29



**PROTÈGE DISQUE ARRIÈRE**  
REAR DISC GUARD

→ YC110-1010

€ 15



**VIS ET ÉCROU TENDEUR DE CHAÎNE**  
BOLT AND NUT FOR BLOCK AXLE

01 → GB5783-M8X40-W (VIS/ SCREW)  
02 → FB6170-M8-W (ÉCROU/ NUT)

€ 3

€ 2



**AXE BRAS OSCILLANT**  
AXLE SWING ARM

01 → YC110-10-03 (Ø 10/ L: 185mm)  
02 → YC110-10-034 (Ø 10/ L: 192mm)  
02 → YC110-10-033 (Ø 12/ L: 236mm: FACTORY 2012-21)  
02 → YC110-10-035 (Ø 12/ L: 240mm: PILOT)  
04 → YC110-1009-01 (Ø 15: PILOT/ BIGY 2018-21)

€ 8

**ROULEMENT BRAS OSCILLANT**  
SWING ARM BEARING

03 → 6200/30-10 (Ø EXT, 30/ Ø INT, 10)  
03 → 6001/28-10 (Ø EXT, 28/ Ø INT, 10)  
03 → 6001/28-12-08 (Ø EXT, 28/ Ø INT, 12)  
03 → 6001/28-15-08 (Ø EXT, 28/ Ø INT, 15) (PILOT/ BIGY 2018-21)

€ 8

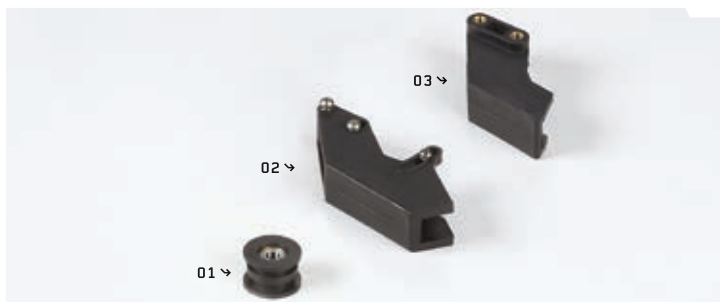

**ROULETTE CHAÎNE**  
CHAIN TENSIONER

01 → YC110-2201-02  
01 → YC50-2201-02 (50E-W88)  
01 → YC110-2201-03 (SP3)

€ 12

**GUIDE CHAÎNE ARRIÈRE**  
REAR CHAIN GUIDE

02 → YC110-1004 (FACTORY 2012-2018/ PILOT - BIGY - SUNDAY)  
03 → YC110-1005 (START)

€ 39



**GUIDE CHAÎNE RENFORCÉ FACTORY 2019-21 ADAPTABLE SUR TOUTES LES PILOT/ FACTORY/ BIGY**

2019-21 FACTORY REINFORCED CHAIN GUIDE SUITABLE FOR ALL PILOT/ FACTORY/ BIGY

→ YC110-1018-04

€ 45



**PATIN CHAÎNE R START 2011-2021**  
CHAIN SLIDER FOR R START 2011-2021

01 → YC110-10-023

€ 12

**PATIN BRAS OSCILLANT POUR BRAS ALU 420mm OU 460mm 2011-2021**  
SWING ARM SLIDER FOR 420mm OR 460mm ALUMINIUM ARM 2011-2021

02 → YC110-10-025

€ 12

**PATIN BRAS OSCILLANT CANTILEVER LITE**  
LITE CANTILEVER SWING ARM SLIDER

03 → YC110-1005-02

€ 12

**PATIN CHAÎNE COURT POUR BRAS CANTILEVER**  
SHORT CHAIN SLIDER ADAPTABLE FOR CANTILEVER ARM

04 → YC110-10-021

€ 10

# AMORTISSEURS SHOCK ABSORBERS

**FACTORY**  
SPECIAL PARTS  
YCF RACING



## AMORTISSEUR SHOCK ABSORBER

01	→ YC50-0404-03 (200mm YCF 50)	€ 89
02	→ YC110-0404-82 (270mm CANTILVER - LITE 88 - 125)	€ 99
04	→ YC110-0404-15 (265mm MONO ARM/ BRAS - START F88)	€ 129
04	→ YC110-0404-14 (270mm MONO ARM/ BRAS - START F125)	€ 129
04	→ YC110-0404-17 (310mm MONO ARM/ BRAS - PILOT 125/150 2013-21 & SM150 2013-21)	€ 129
04	→ YC110-0404-81 (330mm MONO ARM/BRAS PILOT 125/150 2020-21)	€ 139
04	→ YC110-0404-67 (355mm MONO ARM/ BRAS - BIGY)	€ 139
03	→ YC110-0404-07 (280mm RÉGLABLE/ ADJUSTABLE)	€ 179
03	→ YC110-0404-16 (330mm RÉGLABLE/ ADJUSTABLE - SP2)	€ 179
03	→ YC110-0404-68 (355mm RÉGLABLE/ ADJUSTABLE - BIGY)	€ 179

## ENTRETOISE D'AMORTISSEUR Ø 12 SHOCK ABSORBER SPACERS Ø 12

05	→ YC110-04192 (RSP, CLASSIC, FACTORY 2010-2021)	€ 6
06	→ YC110-0419 (START/ PILOT 2010-2021)	€ 4



## AMORTISSEUR DNM DNM SHOCK ABSORBER

→ YC110-0404-83	270mm ressort/spring 800lbs	€ 319
→ YC110-0404-84	270mm ressort/spring 1000lbs	€ 319
→ YC110-0404-35	310mm ressort/spring 1000lbs	€ 319



## RESSORT PLUS SOUPLE ET PLUS DUR SOFTER AND HARDER SPRING

01	→ YC110-0417-22-WH (START/ SM 88-125)	€ 35
	→ YC110-0417-23-WH (PILOT 125-150/ SM 150) (SOUPLE 600 lbs)	€ 39
02	→ YC110-0417-27-BK (START/ SM 88-125)	€ 35
	→ YC110-0417-28-BK (PILOT 125-150/ SM 150) (DUR 800 lbs)	€ 39



## BAVETTE D'AMORTISSEUR YCF YCF MUD FLAP

→ YC110-0460-01	(POUR/FOR PILOT/FACTORY/BIGY)	€ 15
-----------------	-------------------------------	------



## KIT RABASSE AMORTISSEUR HEIGHT ADJUSTMENT KIT

01	→ YC110-1033-01 (START 88S-125-125S)	€ 59
02	→ YC110-1030-02 (LITE)	€ 59



# ROUES, JANTES & MOYEUX WHEELS, RIMS & HUBS



**KIT ROUE SUPERMOTO MOBSTER 12'**  
(2.15 X 12' AVANT/ 3.00 X 12' ARRIÈRE)

MOBSTER SUPERMOTO PAIR OF WHEELS SET 12'  
(2.15 X 12' FRONT/ 3.00 X 12' REAR)

→ KWMOBSTER01-BK

€ 259



**KIT ROUE SUPERMOTO MOBSTER VORTEX 12'**  
(2.15 X 12' AVANT/ 2.75 X 12' ARRIÈRE)

MOBSTER VORTEX SUPERMOTO WHEELS SET 12'  
(2.15 X 12' FRONT/ 2.75 X 12' REAR)

→ KWMOBSTER02-BK

€ 299



**ROUE SUPERMOTO ALU**  
(VENDUE AVEC DISQUE DE FREIN & COURONNE)

SUPERMOTO WHEEL ALU  
(SOLD WITH BRAKE DISC & SPROCKET)

→ YC110-0601-93 (2.15x14 AVANT/ FRONT) € 149

→ YC110-1101-73 (3.00x14 ARRIÈRE/ REAR) € 169



**NEW  
2021**

**KIT ROUE SUPERMOTO YCF 10'**  
(2.15 X 10' AVANT/ 2.50 X 10' ARRIÈRE)

YCF SUPERMOTO WHEEL SET 10'  
(2.15 X 10' FRONT/ 2.50 X 10' REAR)

→ YC110-0625-01-BK

€ 259



**NEW  
2021**

**KIT ROUE SUPERMOTO YCF 12'**  
(2.15 X 12' AVANT/ 2.75 X 12' ARRIÈRE)

YCF SUPERMOTO WHEEL SET 12'  
(2.15 X 12' FRONT/ 2.75 X 12' REAR)

→ YC110-0626-01-BK

€ 299



**ROUE SUPERMOTO (ACIER)**  
(VENDUE AVEC DISQUE DE FREIN & COURONNE)

SUPERMOTO STEEL WHEEL  
(SOLD WITH BRAKE DISC)

→ YC110-06017 (1,85x12 AVANT/ FRONT) € 119

→ YC110-11014 (2,15x12 ARRIÈRE/ REAR) € 129



**ROUE ACIER POUR AXE DE ROUE DE 15 AVEC RAYONS RENFORCÉS 4mm**

STEEL WHEEL FOR 15" WHEEL AXLE WITH 4mm REINFORCED SPOKES

- YC110-0601-2901 (AVANT/ FRONT 12) € 119
- YC110-0601-30-BK (AVANT/ FRONT 14) € 119
- YC110-0601-0801 (88CC: AVANT/ FRONT 10) € 99
- YC110-1101-34-BK (ARRIÈRE/ REAR 12) € 149
- YC110-1101-01A (ARRIÈRE/ REAR 10) € 149



**ROUE AVANT OU ARRIÈRE COMPLÈTE YCF 50**

COMPLETE FRONT OR REAR WHEEL FOR YCF 50

- YC50-0601-0401 (AVANT/ FRONT) € 99
- YC50-1101-0401 (ARRIÈRE/ REAR) € 139



**ROUE COMPLÈTE AVEC MOYEURS CNC ROUGE/ BLEUE/ VERTE/ ORANGE/ NOIRE**

COMPLETE WHEEL WITH CNC HUB RED/ BLUE/ GREEN/ ORANGE/ BLACK

- YC50-0611-01 + COLOR (AVANT/ FRONT) € 119
- YC50-1101 + COLOR (ARRIÈRE/ REAR) € 149



**ROUE COMPLÈTE ACIER RENFORCÉE POUR AXE DE ROUE DE 15, MOYEURS ARRIÈRE AVEC 5 VIS DE FIXATION POUR COURONNE**

COMPLETE REINFORCED STEEL WHEEL AXLE 15, REAR HUB WITH 5 SCREWS FIXATION FOR SPROCKET

- YC110-1101-2D (ARRIÈRE/ REAR 12) € 149
- YC110-0601-5B (AVANT/ FRONT 14) € 129



**ROUE COMPLÈTE ACIER RENFORCÉE POUR AXE DE ROUE DE 15, MOYEURS ARRIÈRE AVEC 5 VIS DE FIXATION POUR COURONNE**

COMPLETE REINFORCED STEEL WHEEL AXLE 15, REAR HUB WITH 5 SCREWS FIXATION FOR SPROCKET

- YC110-1101-29-BK (ARRIÈRE/ REAR 14) € 149
- YC110-0601-39-BK (AVANT/ FRONT 17) € 139



ROUE COMPLÈTE RENFORCÉE, MOYEURS CNC,  
CERCEAU ALU, 7116, VENDUE AVEC DISQUE & COURONNE  
ROUGE/ BLEU/ ORANGE/ NOIRE/ VERTE

COMPLETE REINFORCED WHEEL, CNC HUB, ALU,  
7116 RIM (SOLD WITH BRAKE DISC & SPROCKET)  
RED/ BLUE/ ORANGE/ BLACK/ GREEN

→ YC110-0601-40 + COLOR (AVANT/ FRONT 17) € 179  
→ YC110-1101-32 + COLOR (ARRIÈRE/ REAR 14) € 199



**FACTORY**  
SPECIAL PARTS  
YCF RACING

**AT 7116**

**YCF**



**ROUE COMPLÈTE RENFORCÉE, MOYEURS CNC, CERCEAU ALU, 7116, VENDUE AVEC DISQUE & COURONNE ROUGE/ BLEU/ ORANGE/ NOIRE/ VERTE**  
COMPLETE REINFORCED WHEEL, CNC HUB, ALU, 7116 RIM (SOLD WITH BRAKE DISC & SPROCKET) RED/ BLUE/ ORANGE/ BLACK/ GREEN

- YC110-06012 + COLOR (AVANT/ FRONT 12)
- YC110-0601-37 (AVANT/ FRONT 14)
- YC110-1101-25 (ARRIÈRE/ REAR 12)

€ 129  
€ 159  
€ 199

**AL 7116**



**CERCEAU DE ROUE ALU. 7116**  
ALUMINIUM 7116 M SHAPE RIM

- YC110-1117-16-BK (1,85x12 AV./ FRONT - AR./ REAR)
- YC110-1117-16-SI (1,85x12 IDEM) € 59
- YC110-0617-22BK (1,40x14 AV./ FRONT)
- YC110-0617-22SI (1,40x14 AV./ FRONT) € 59
- YC110-0617-40-BK (1,60x17 AV./ FRONT) € 59
- YC110-1107-32-BK (1,85x14 AR./ REAR) € 59



**CERCEAU DE ROUE ACIER POUR RAYON 4mm**  
STEEL RIM WITH 4mm SPOKES

- ↪ YC110-1107-34-BK (1,85X12 AV./ FRONT - AR./ REAR) € 30
- ↪ YC110-1101-014 (2,15X12 AV./ FRONT - AR./ REAR) € 30
- ↪ YC110-0617-19-BK (1,40x12 AV./ FRONT) € 30
- ↪ YC110-0617-30-BK (1,40x14 AV./ FRONT) € 30
- ↪ YC110-0617-39-BK (1,60x17 AV./ FRONT) € 30
- ↪ YC110-1107-29-BK (1,85x14 AR./ REAR) € 30



**ROULEMENT DE ROUE AVANT OU ARRIÈRE**  
FRONT OR REAR WHEEL BEARING

- 01 ↪ 96140-6202-2Z € 8

**JOINT SPY DE ROUE**  
WHEEL OIL SEAL

- 02 ↪ YC50-0610 (Ø22X31.5X5) (POUR/ FOR YCF 50)
- 02 ↪ YC110-0610 (Ø25X35X6.5)  
(POUR MOYEUX CNC 2012/ FOR CNC HUB)
- 02 ↪ YC110-0611 (Ø23X35X5) (POUR MOYEUX  
INJECTÉ-CNC/ FOR MOLDED-CNC HUB) € 6

**GRIPSTER ARRIÈRE OU AVANT**  
REAR OR FRONT RIM LOCK

- 03 ↪ GRIPSTERAR-R (ARRIÈRE/ REAR)
- 03 ↪ GRIPSTERA-V-R (AVANT/ FRONT) € 12



**JEU DE RAYONS AVANT OU ARRIÈRE 4mm**  
FRONT OR REAR SET OF SPOKES 4mm

AVANT/ FRONT:

- ↪ JR10-10.6 (50A/ 50E)
- ↪ JR12-12.1-8K (88E/ START 88SE)
- ↪ JR10-10.1-8K (LITE 88)
- ↪ JR14-14.8-8K (LITE 125/ START 125S/ START 125SE  
/ PILOT 125/ PILOT 150)
- ↪ JR14-15.0-8K (SP2/ SP3)
- ↪ JR17-18.4-8K (BIGY 125/ 150)
- ↪ JR17-18.5-8K (BIGY F150/ 190D/ 190ZE)
- ↪ JR12-12.5 (SM) € 25

ARRIÈRE/ REAR:

- ↪ JR10-10.5 (50A/ 50E)
- ↪ JR10-10.4-8K (88E/ LITE 88/ START 88SE)
- ↪ JR12-12.8-8K (LITE 125/ START 125S/ START 125SE  
/ PILOT 125/ PILOT 150)
- ↪ JR12-13.5-8K (SP2/ SP3)
- ↪ JR14-15-8K (BIGY 125/ 150)
- ↪ JR14-15.1-8K (BIGY F150/ 190D/ 190ZE)
- ↪ JR12-12.6-10K (SM) € 25



**AXE DE ROUE AVANT OU ARRIÈRE**  
FRONT OR REAR WHEEL AXLE

- 01 ↪ YC110-11-075 (FACTORY 2011-2021)
- 02 ↪ YC110-11-07 (ARRIÈRE/ REAR)
- 03 ↪ YC110-06-06 (AVANT/ FRONT)
- 04 ↪ YC110-06-061 (TYPE MARZOCCHI®) € 8



**COUVRE RAYON (KIT DE 38 PCS AVANT 215 MM/ 38 PCS ARRIÈRE 190mm)**  
ROSE/ ROUGE/ BLEUE/ JAUNE/ VERT/ ORANGE

SPOKE SKIN SET (INCLUDES 38 FRONT PCS-215mm & 38 REAR PCS-190mm)  
PINK/ RED/ BLUE/ YELLOW/ GREEN/ ORANGE

↪ SPKAS01-COLOR

€ 15



**MOYEURS ROUE AVANT OU ARRIÈRE CNC BLEU/ ROUGE/ ORANGE/ VERT/ NOIR**  
WHEEL HUB CNC FRONT OR REAR RED/ ORANGE/ GREEN/ BLUE/ BLACK

- 01 → YC110-0622-22 + COLOR (AVANT/ FRONT) € 99  
02 → YC110-1122-16 + COLOR (ARRIÈRE/ REAR) € 119

**JEU ENTRETOISES DE ROUE CNC POUR MOYEURS INJECTÉE LITE/ START/ PILOT/ BIGY MX125/150 BLEUES/ ROUGES/ NOIRES/ ORANGES/ VERTES**  
SET OF CNC WHEEL SPACERS FOR CASTING HUB LITE/ START/ PILOT/ BIGY MX125/150 BLUE/ RED/ BLACK/ ORANGE/ GREEN

- 03 → ERC1AV + COLOR (AVANT/ FRONT 15x22x33 & 15x22x23) € 15  
03 → ERC1AR + COLOR (ARRIÈRE/ REAR 15x22x38 & 15x22x29)

**ENTRETOISE DE ROUE**  
WHEEL SPACER

- 04 → YC110-06-052 (AVANT GAUCHE/ FRONT LEFT) Ø 15X22X33 LITE/ START/ PILOT/ BIGY MX125-150  
04 → YC110-06-047 (AVANT DROITE/ FRONT RIGHT) Ø 15X22X23 LITE/ START/ PILOT/ BIGY MX125-150  
04 → YC110-11-052 (ARRIÈRE GAUCHE/ REAR LEFT) Ø 15X22X38 LITE/ START/ PILOT/ BIGY MX125-150  
04 → YC110-11-041 (ARRIÈRE DROITE/ REAR RIGHT) Ø 15X22X29 LITE/ START/ PILOT/ BIGY MX125-150 € 5

**ENTRETOISE DE ROUE MOBSTER**  
MOBSTER WHEEL SPACER

- FB13-15X22X19-W (AVANT DROITE) € 6  
→ FB13-15X22X23-W (ARRIÈRE DROITE)  
→ FB13-15X22X28-W (AVANT GAUCHE)  
→ FB13-15X22X34-W (ARRIÈRE GAUCHE)

**ENTRETOISE CENTRALE DE MOYEURS**  
CENTRAL HUB SPACER

- 05 → YC110-0601-02 (CENTRAL AVANT/ FRONT) Ø 15x22x44  
05 → YC110-0601-021 (CENTRAL AVANT/ FRONT) Ø 16x21x53  
05 → YC110-0601-022 (CENTRAL AVANT/ FRONT) Ø 15x22x43  
05 → YC110-1101-03 (INT, ARRIÈRE/ INNER REAR) Ø 16x21x84  
05 → YC110-1101-04 (INT, ARRIÈRE/ INNER REAR) Ø 16x21x64  
05 → YC110-1101-05 (INT, ARRIÈRE/ INNER REAR) Ø 16x21x59  
05 → YC110-1101-06 (INT, ARRIÈRE/ INNER REAR) Ø 16x21x74 € 5

**ENTRETOISE SP3 2019 (TÉ 170 mm)**  
CENTRAL HUB SPACER

- 04 → YC110-0609-08 (AVANT DROITE/ FRONT RIGHT)  
04 → YC110-0610-08 (AVANT GAUCHE/ FRONT LEFT) € 5



**FACTORY**  
SPECIAL PARTS  
YCF RACING

**AI 7116**



# PNEUS TIRES



**CHAMBRE À AIR RENFORCÉE 4mm**  
REINFORCED TUBE 4mm

- 01 → CHAMBRE10RENF (Ø 10" FRONT-REAR/ AV,-AR,) € 12
- 01 → CHAMBRE12RENF (Ø 12" FRONT-REAR/ AV,-AR,) € 12
- 01 → CHAMBRE14RENF (Ø 14" AV,/ FRONT) € 12
- 01 → CHAMBRE14ARRENF (Ø 14" AR,/ REAR) € 15
- 01 → CHAMBRE17RENF (Ø 17" AV,/ FRONT) € 15

**CHAMBRE À AIR STANDARD**  
STANDARD TUBE

- 01 → CHAMBRE10-2,5 (Ø 10" POUR/ FOR YCF 50) € 8
- 01 → CHAMBRE12AV (Ø 12" AVANT/ FRONT) € 9

**FOND JANTE**  
TIRE LINING

- 02 → YC110-11-01 (ROUE/ WHEEL 10/12")
  - 02 → YC110-06-01 (ROUE/ WHEEL 14")
  - 02 → YC110-06-07 (ROUE/ WHEEL 17")
- € 2**



**BOUCHON DE VALVE CNC**  
BLEU/ ROUGE/ NOIR/ ORANGE/ VERT  
VALVE CAP SET  
BLUE/ RED/ BLACK/ ORANGE/ GREEN

→ TVC + COLOR **€ 4**



**PNEU AVANT CROSS 2,50/10**  
FRONT CROSS TIRE IN 2,50/10

→ 250/10 **€ 25**



**PNEU ARRIÈRE CROSS EN 3,00/10**  
REAR CROSS TIRE IN 3,00/10

→ 300/10 **€ 32**



**PNEU AVANT CROSS EN 60/100/12**  
FRONT CROSS TIRE IN 60/100/12

→ 60/100/12 **€ 27**



**PNEU ARRIÈRE CROSS EN 80/100/12**  
REAR CROSS TIRE IN 80/100/12

→ 300/12 **€ 28**



**PNEU AVANT CROSS EN 60/100/14**  
FRONT CROSS TIRE IN 60/100/14

→ 60/100/14 **€ 27**



**PNEU ARRIÈRE CROSS EN 90/100/14**  
REAR CROSS TIRE IN 90/100/14

→ 90/100/14 **€ 39**



**PNEU AVANT CROSS EN 70/100/17**  
FRONT CROSS TIRE IN 70/100/17

→ 70/100/17 **€ 39**



**PNEU 90/90/10**  
TIRE 90/90/10

→ 90/90/10 **€ 39**

**KENDA**

**NEW  
2021**



**PNEU KENDA® SUPERMOTARD K702**  
KENDA® SUPERMOTARD K702 TIRE

- 90/90-10K702
- 100/90-10K702
- 110/70-12K702
- 120/70-12K702

€ 55  
€ 55  
€ 59  
€ 59



**ARRO™**



**PNEU ARRO® SPIDER CROSS EN 300/10**  
SPIDER ARRO® TIRE 300/10

→ 300/10 ARRO

€ 39

**ARRO™**



**PNEU ARRO® SPIDER CROSS AVANT EN 60/100/12**  
SPIDER ARRO® TIRE FRONT 60/100/12

→ 60/100/12 ARRO

€ 39

**ARRO™**



**PNEU ARRO® SPIDER CROSS ARR, EN 80/100/12**  
SPIDER ARRO® TIRE REAR 80/100/12

→ 80/100/12ARRO

€ 42

**ARRO™**



**PNEU ARRO® SPIDER CROSS AVANT EN 60/100/14**  
SPIDER ARRO® TIRE FRONT 60/100/14

→ 60/100/14ARRO

€ 41

**ARRO™**



**PNEU ARRO® SPIDER CROSS ARR, EN 90/100/14**  
SPIDER ARRO® TIRE TRAR 90/100/14

→ 90/100/14 ARRO

€ 50

**ARRO™**



**PNEU ARRO® SPIDER® CROSS AVANT EN 70/100/17**  
SPIDER ARRO® TIRE FRONT 70/100/17

→ 70/100/17 ARRO

€ 48

# REPOSE-PIEDS & SABOTS FOOT PEGS & SKID PLATES



**BARRE DE REPOSE-PIED**  
FOOT PEGS MOUNT BAR

→ YC110-0901-01 (GAMME START/ START RANGE) € 29



**RÉSERVOIR RÉCUPÉRATEUR DE LIQUIDE  
AVEC SEPARATEUR HUILE/ ESSENCE**  
RECUPERATOR TANK WITH SEPARATOR OIL/ GAZ

→ YC110-0816-02 € 39



**PLATINE RÉGLABLE AVEC REPOSE-PIED SUPERMOTARD**  
SUPERMOTARD ADJUSTABLE FOOT PEGS KIT

→ YC110-0919-01 € 69



**SABOT MOTEUR ACIER**  
STEEL SKID PLATE

→ YC110-202-01 (ACIER/ STEEL 88/125/140) € 39  
→ YC110-202-02 (ACIER/ STEEL 88/125 SE) € 39  
→ YC110-0905-02 (ACIER/ STEEL 88/125/140) € 49

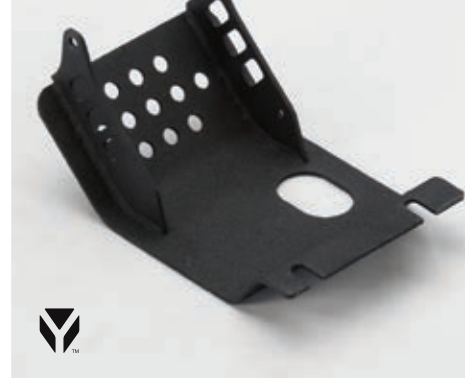

**SABOT POUR FACTORY**  
SKID PLATE FOR FACTORY

→ YC110-207-03 (FACTORY SP1) € 49  
→ YC110-207-04 (FACTORY SP2)  
→ YC110-207-05 (FACTORY SP3)



**NEW  
2021**



**SABOT RÉCUPÉRATEUR HUILE SUPERMOTARD EN  
FIBRE DE VERRE BLANC/ NOIR**  
RACE BELLY PAN WHITE/ BLACK

→ YC110-202-03-WH € 79  
→ YC110-202-03-BK € 79  
(Adaptable sur toute la gamme YCF/ fit on all YCF range)



**FACTORY**  
SPECIAL PARTS  
YCF RACING

**JEU DE REPOSE-PIED ALUMINIUM NOIR/ ROUGE/ BLEU/ ORANGE/ VERT**  
ALUMINIUM FOOT PEGS BLACK/ RED/ BLUE/ ORANGE/ GREEN

→ RPALU + COLOR € 69

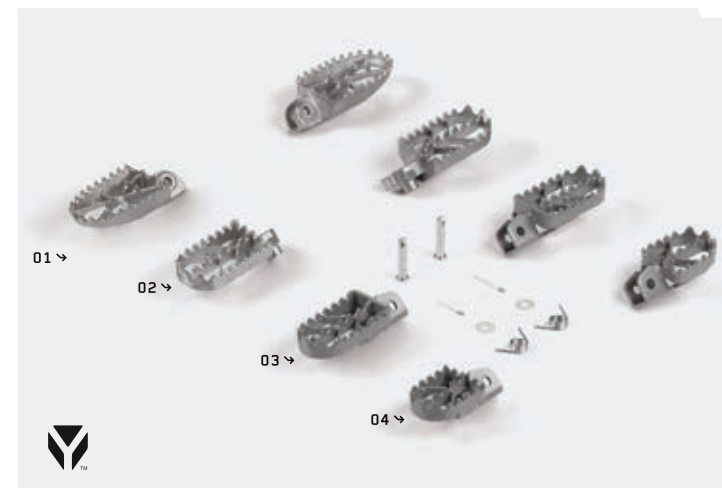

**JEU DE REPOSE-PIED**  
FOOT PEGS SET

01 → YC110-0902/05 (INOX LARGE/ LARGE STAINLESS STEEL)  
02 → YC110-0902/04 (INOX/ STAINLESS STEEL) € 49  
03 → YC110-0902/13 (ACIER/ STEEL)  
04 → YC110-0902/06 (SUPERMOTO) € 29





**KIT COMPLET PROTECTION TEFLON SUPERMOTO**  
SUPERMOTO TEFLON PROTECTION SET

→ KS1 € 59



**KIT PATIN TEFLON SUPERMOTO**  
SUPERMOTO TEFLON SET

→ KS4 € 35



**KIT BOCAL RÉCUPÉRATEUR HUILE ET ESSENCE SUPERMOTO**  
SUPERMOTO OIL AND FUEL RECUPERATOR KIT

→ KS3 € 29

# SÉLECTEURS SHIFT LEVERS



**SÉLECTEUR ALUMINIUM CNC AVEC DÉPORT POUR AXE SÉLECTEUR COURT**  
NOIR/ BLEU/ ROUGE/ ORANGE/ VERT  
ALUMINIUM CNC GEAR LEVER WITH EXTENSION FOR SHORT LEVER SHAFT  
BLACK/ BLUE/ RED/ ORANGE/ GREEN

01 → STMD + COLOR € 39

**SÉLECTEUR ALUMINIUM NOIR/ BLEU/ ROUGE/ ORANGE/ VERT**  
ALUMINIUM SHIFT LEVER BLACK/ BLUE/ RED/ ORANGE/ GREEN

02 → 24700 + COLOR € 29



**KICK ACIER ORIGINE**  
ORIGINAL STEEL KICKSTARTER

01 → 43451/152FMH (Ø 13mm) € 15  
01 → 43452/152FMH (Ø 16mm)

**KICK ACIER RENFORCÉ**  
REINFORCED KICKSTARTER

02 → YC140-27500SI (Ø 13mm) € 50  
02 → YC140-27600SI (Ø 16mm)

**RESSORT/ BILLE/ VIS POUR KICK**  
BALL, SPRING, AND SCREW FOR KICKSTARTER

03 → KVK € 3

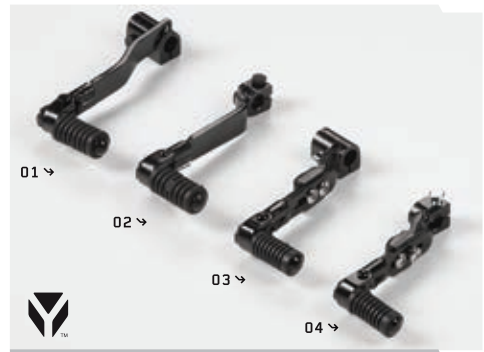

**SÉLECTEUR ACIER REPLIABLE**  
FOLDABLE STEEL SHIFT LEVER

01 → 24700/152FMI/3V (AVEC DÉPORT/ WITH EXT.)  
01 → 24700/152FMH/02 (190 ZONGSHEN ENGIN)  
02 → 24700/152FMH/03 € 13

**SÉLECTEUR ACIER REPLIABLE ET RÉGLABLE**  
FOLDABLE & ADJUSTABLE STEEL SHIFT LEVER

03 → 24700-D (AVEC DÉPORT/ WITH EXT.)  
04 → 24700-SD € 15

# KIT CHAÎNE & TRANSMISSION SPROCKET KITS & TRANSMISSIONS

SPECIAL PARTS  
YCF RACING



**COURONNE ACIER Ø INTÉRIEUR 75 - ENTRAXE COURONNE 92 - 5 TROUS DE FIXATION POUR FACTORY 2016-21**

STEEL SPROCKET INNER Ø 75 - SPROCKET CENTRE TO CENTRE DISTANCE 92 - 5 HOLES FIXATION FOR FACTORY 2016-21

- YC110-11-062/41 (41 DENTS/ TEETH)
- YC110-11-062/45 (45 DENTS/ TEETH)

€ 19



01 →



02 →



03 →

**PIGNON SORTIE BOÎTE & PLAQUE PIGNON**

COUNTERSHAFT SPROCKET & SPROCKET PLATE

- 01 → 22711/152FMI14 (Ø 20 PIGNON 14 DENTS/ SPROCKET 14 TEETH)
- 01 → 22711/152FMI15 (Ø 20 PIGNON 15 DENTS/ SPROCKET 15 TEETH)
- 02 → 22712/152FMH (Ø 17 PLAQUE PIGNON/ SPROCKET PLATE)
- 02 → 22712/152FMI (Ø 20 PLAQUE PIGNON/ SPROCKET PLATE)
- 03 → RS35/10T (PIGNON 10 DENTS YCF 50E/ YCF 50E SPROCKET 10 TEETH)
- 03 → RS35/10T-01 (PIGNON 10 DENTS W88/ W88 SPROCKET 10 TEETH)

€ 10

€ 8

€ 10

SPECIAL PARTS  
YCF RACING



**CHAÎNE RENFORCÉE 420 110 MAILLONS ROUGE/ BLEUE/ VERTE/ ORANGE/ JAUNE**  
REINFORCED CHAIN 420 110 LINKS RED/ BLUE/ GREEN/ ORANGE/ YELLOW

- 420DX-110T + COLOR
- 420DX-116T + COLOR (BIGY)

€ 20  
€ 20

SPECIAL PARTS  
YCF RACING



01 →



02 →



**COURONNE ACIER Ø INTÉRIEUR 75 - ENTRAXE COURONNE 92**

STEEL SPROCKET INNER Ø 75 - SPROCKET CENTRE TO CENTRE DISTANCE 92

- 01 → YC110-11-06/41 (41 DENTS/ TEETH)
- 01 → YC110-11-06/45 (45 DENTS/ TEETH)
- 02 → YC110-11-05/60 (60 DENTS/ TEETH - YCF 50E/ W88)

€ 15  
€ 29

SPECIAL PARTS  
YCF RACING



**PIGNON SORTIE BOÎTE ANTI BOUE Ø 17**  
ANTI MUD COUNTERSHAFT SPROCKET Ø 17

- 22711/152FMZ13 (13 DENTS/ TEETH)
- 22711/152FMZ14 (14 DENTS/ TEETH)
- 22711/152FMZ15 (15 DENTS/ TEETH)
- 22711/152FMZ16 (16 DENTS/ TEETH)
- 22711/152FMZ17 (17 DENTS/ TEETH)
- 420H/10T (10 DENTS/ TEETH) (YCF 50A)

€ 10

01 →



02 →

**CHAÎNE 420 ET RS35**  
CHAIN 420 AND RS35

- 01 → 420H-104T (104 MAILLONS/ LINKS) € 17
- 01 → 420H-110T (110 MAILLONS/ LINKS) € 16
- 01 → 420H-116T (116 MAILLONS/ LINKS BIGY) € 19
- 01 → RS35-114T (114 MAILLONS/ LINKS 50E) € 19

**ATTACHE RAPIDE**

CHAIN JOINING LINK

- 02 → AR-420
- 02 → AR-35 (YCF 50E) € 2



37 39 41 43 45 47

COURONNE ALU. TAILLÉE DANS LA MASSE DISPONIBLE EN 37, 39, 41, 43, 45, 47 DENTS NOIRE/ VERTE/ BLEUE/ ROUGE/ ORANGE  
Ø INTÉRIEUR 75 - ENTRAXE COURONNE 92

BILLET ALUMINIUM SPROCKET AVAILABLE IN 37, 39, 41, 43, 45, 47 TEETH BLACK/ GREEN/ BLUE/ RED/ ORANGE  
INNER Ø 75 - SPROCKET CENTRE TO CENTRE DISTANCE 92

→ CA06R + NOMBRE DENTS & COULEUR/ NUMBER OF TEETH & COLOR

€ 45



**KIT VIS COURONNE**  
SCREW SET FOR SPROCKET

- 01 → KVC
- 02 → KVC-1 (TÊTE FRAISÉE/ FLAT HEAD)
- 04 → KVC-2 (KIT VIS PLATES/ SPROCKET BOLT KIT FLAT HEAD)

€ 4

**BLOC COURONNE**  
BLOCK SPROCKET

03 → YC110-11-03

€ 3



**TENDEUR CHAÎNE CNC NOIR/ ROUGE/ BLEU/ ORANGE/ VERT**  
CNC AXLE BLOCK BLACK/ RED/ BLUE/ ORANGE/ GREEN

- 01 → TC07 + COLOR (Ø 15) (POUR BRAS ACIER/ FOR STEEL SWING ARM)
- 02 → TC12 + COLOR (POUR BRAS ALU/ FOR ALU SWING ARM - 2011-2021)
- 03 → TC-COLOR (Ø 12 RED OR BLACK ONLY/ ROUGE OU NOIR SEULEMENT)

€ 19



41 43 45 47

COURONNE ALU, TAILLÉE DANS LA MASSE - 5 TROUS DE FIXATION POUR FACTORY 2016 - DISPONIBLE EN 41, 43, 45, 47 DENTS NOIRE/ VERTE/ BLEUE/ ROUGE/ ORANGE - Ø INTÉRIEUR 75 - ENTRAXE COURONNE 92

BILLET ALUMINIUM SPROCKET - 5 HOLE FIXATION FOR FACTORY AVAILABLE IN 41, 43, 45, 47 TEETH BLACK/ GREEN/ BLUE/ RED/ ORANGE - INNER Ø 75 - SPROCKET CENTRE TO CENTRE DISTANCE 92

→ CA16R + NOMBRE DENTS & COULEUR/ NUMBER OF TEETH & COLOR

€ 45



**PROTECTION PIGNON SORTIE BOÎTE (VIS & ENTRETOISES INCLUSES)**  
COUNTERSHAFT SPROCKET GUARD (SCREWS & SPACERS INCLUDED)

- 01 → YC110-253BK (PILOT - FACTORY)
- 02 → YC110-251BK (START)

€ 15



**FREIN FILET - ROUGE: FORT/ BLEU: MOYEN**  
**THREADLOCKER - RED: STRONG/ BLUE: MEDIUM**

09 → FF271 (STRONG/ FORT)  
 10 → FF242 (MEDIUM/ MOYEN)

€ 16

**CLÉ À BOUGIE**  
 SPARK PLUG REMOVAL TOOL

01 → CB

€ 6

**ARRACHE VOLANT 3 EN 1**  
**ADAPTABLE SUR TOUS LES MOTEURS DE MINI**  
 FLYWHEEL REMOVER 3 IN 1  
 SUITABLE FOR ALL MINI BIKES ENGINES

02 → ARRACHE-1

€ 12

**OUTIL POUR DÉMONTER NOIX EMBRAYAGE ET ÉPURATEUR**  
 CLUTCH TOOL

03 → OUTIL

€ 17

**DÉRIVE CHAÎNE PROFESSIONNEL**  
 PROFESSIONAL CHAIN TOOL

04 → DERIVE-1

€ 29

**CLÉ À RAYONS**  
 NIPPLE WRENCH

05 → CLEARAYON

€ 7

**JEU DE CALES MOTEUR**  
 SET OF ENGINE ADJUSTMENT GAUGES

06 → JCM-1

€ 7

**CONTRÔLEUR DIGITAL DE PRESSION DE PNEU**  
 DIGITAL TIRE PRESSURE GAUGE

07 → CDP

€ 16

**DÉMONTE PNEU EN CUILLÈRE**  
 SPOON TIRE LEVER

08 → DEMONT-1

€ 10

**OUTIL RÉGLAGE SOUPAPES**  
 VALVE ADJUSTMENT TOOL/ WRENCH

**NEW  
2021**

11 → YC110-2410-01

€ 9





**KIT DÉPART ENGI®**  
ENGI® LAUNCH CONTROL

→ ENGIHKF-BK

€ 59



**BAGUE/ JOINT SPI/ CACHE POUSSIÈRE FOURCHE**  
FORK RING/ OIL SEAL/ DUST COVER

- 01 → EF03-0027 (INFÉRIEURE/ LOWER) € 12
- 02 → EF03-0005 (SUPERIEURE/ UPPER) € 12
- 03 → EF03-0009-01 (ENGI®) € 8
- 04 → EF03-0011-01 (ENGI®)  
(VENDU À L'UNITÉ/ SELL BY UNIT) € 12



**FOURCHE ENGI® RÉGLABLE COMPRESSION DÉTENTE AVEC CORPS ALUMINIUM ET TRAITEMENT DU TUBE INF.**  
ENGI® FORK WITH ADJUSTABLE COMPRESSION & REBOUND

→ ENGI2-800-BK (800mm)

€ 649



**FOURCHE ENGI® RÉGLABLE COMPRESSION DÉTENTE**  
ENGI® FORK WITH ADJUSTABLE COMPRESSION & REBOUND

→ ENGI1660 (660mm)  
→ ENGI1735 (735mm)

€ 549  
€ 599



**OUTIL ASSEMBLAGE JOINT SPI ENGI®**  
ENGI® OIL SEAL ASSEMBLY TOOL

01 → ENGI-OST

€ 79

**OUTIL CLÉ EN T ENGI®**  
ENGI® T-HANDLE WRENCH TOOL

02 → ENGI-PDR

€ 59



**AMORTISSEUR ENGI® RÉGLABLE COMPRESSION DÉTENTE**  
 ENGI® SHOCK ABSORBER ADJUSTABLE COMPRESSION & REBOUND

- YC110-0404-65 (270mm PILOT) € 219
- YC110-0404-61 (300mm PILOT) € 219
- YC110-0404-66 (310mm PILOT) € 279
- YC110-0404-63 (335mm FACTORY) € 279
- YC110-0404-69 (355mm BIGY) € 299



**KIT RÉFECTION INTERIEUR AMORTISSEUR**  
 ENGI® SHOCK INTERNAL REPAIR KIT

→ ES01-000B

€ 69



**KIT RÉFECTION ENTRETOISE AXE AMORTISSEUR**  
 ENGI® SHOCK SPACER KIT

→ ES01-000C

€ 25





# ENGINE PARTS

## PIÈCES MOTEUR

MOTEURS DAYTONA®/ DAYTONA® ENGINES	112
MOTEURS/ ENGINES	113
KITS MOTEUR/ ENGINE KITS	114
EMBAYAGE/ CLUTCH	116
KITS DRESS UP/ DRESS UP KITS	118
CARBURATEURS/ CARBURETORS	120
FILTRES À AIR/ AIR FILTERS	122
ÉCHAPPEMENTS/ EXHAUSTS	123
FILTRES & RADIATEURS/ FILTERS & COOLERS	126
ALLUMAGE/ IGNITION	128
PIÈCES RACING DAYTONA®/ DAYTONA® RACING PARTS	130
PIÈCES D'ORIGINES DAYTONA®/ DAYTONA® PARTS	131



# MOTEURS ENGINES

# DAYTONA®

DAYTONA® EST UNE SOCIÉTÉ JAPONNAISE SPÉCIALISÉE DANS LE DÉVELOPPEMENT ET LA FABRICATION DE PIÈCES HAUTE PERFORMANCE MOTOS DEPUIS 1972. L'ENTREPRISE EST UN LEADER INTERNATIONAL DE L'INDUSTRIE DES PIÈCES RACING.  
(DÉTAIL DES PIÈCES À PARTIR DE LA PAGE 130)

DAYTONA® IS A JAPANESE COMPANY SPECIALIZED IN HIGH PERFORMANCE PARTS. THEY HAVE BEEN A LEADER IN MOTORCYCLE INDUSTRY SINCE 1972. THEY PROVIDE ORIGINAL AND RACING PARTS FOR MOTORCYCLE TO THE INTERNATIONAL MARKETPLACE.  
(SEE PARTS DETAILS FROM PAGE 130)

→ CARTER RENFORCÉ  
→ REINFORCED CRANKCASE

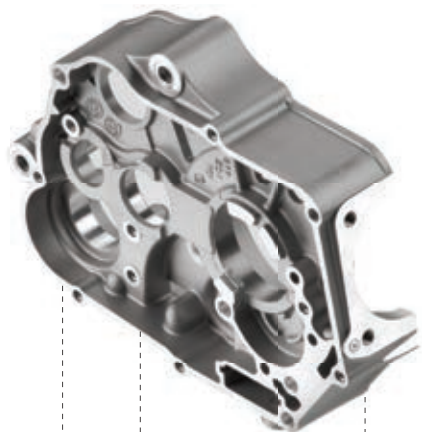

FEATURING

→ DÉCOMPRESSEUR AUTOMATIQUE  
→ DECOMPRESSION SYSTEM



DAYTONA



## ANIMA® 2.0 MX

MOTEURS DAYTONA® ANIMA® 2,0  
DAYTONA® ANIMA® 2.0 ENGINES

- 88026 (150cc FSM) € 1099
- 87615 (190cc, 4 SPEEDS) € 1199
- 88025 (ANIMA® 160cc, FSM, 4 SPEEDS) € 1199
- 89734 (190cc, 5 SPEEDS) € 1249



MOTEUR DAYTONA® 190cc FE DÉMARREUR ÉLECTRIQUE 5 VITESSES  
DAYTONA® 190cc FE ENGINE ELECTRIC START 5 SPEEDS

- 88392 € 1199

# ZONGSHEN



MOTEUR ZONGSHEN® FIDDY  
ZONGSHEN® FIDDY ENGINE

- MOTEUR110-G € 449
- MOTEUR125-G € 499
- MOTEUR150ZS € 599

**MOTEUR 50 YCF 2012-2020 AUTOMATIC**  
YCF 50 ENGINE 2012-2020 AUTOMATIC

01 ↘ MOTEUR50-01-GY € 349

**MOTEUR 125 À DÉMARREUR**  
125 4 SPEED SEMI-AUTOMATIC ENGINE ELECTRIC START

02 ↘ MOTEUR125SELE-01 € 479

**MOTEUR 88 À DÉMARREUR**  
88 4 SPEED SEMI-AUTOMATIC ENGINE ELECTRIC START

03 ↘ MOTEUR88ELE-02 € 449

**MOTEUR 88 4 VITESSES SEMI-AUTOMATIC**  
88 4 SPEED SEMI-AUTOMATIC ENGINE

04 ↘ MOTEUR88 € 379

**MOTEUR 125 POINT MORT**  
125 NEUTRAL ENGINE

05 ↘ MOTEUR125P € 349

**MOTEUR 125 4 VITESSES SEMI-AUTOMATIC**  
125 4 SPEED SEMI-AUTOMATIC ENGINE

06 ↘ MOTEUR125SEMI € 399

**MOTEUR 150 TYPE KLX**  
150 ENGINE TYPE KLX

07 ↘ MOTEUR150-02 € 649

**MOTEUR 150-3**  
150-3 ENGINE

08 ↘ MOTEUR150-3 € 529

**MOTEUR 150 TYPE CRF**  
150 ENGINE TYPE CRF

09 ↘ MOTEUR150-5 € 599

**MOTEUR 190 ZONGSHEN® DÉMARREUR ÉLECTRIQUE**  
5 VITESSES  
190 ZONGSHEN® ENGINE ELECTRIC START 5 SPEEDS

10 ↘ MOTEUR190ES € 799

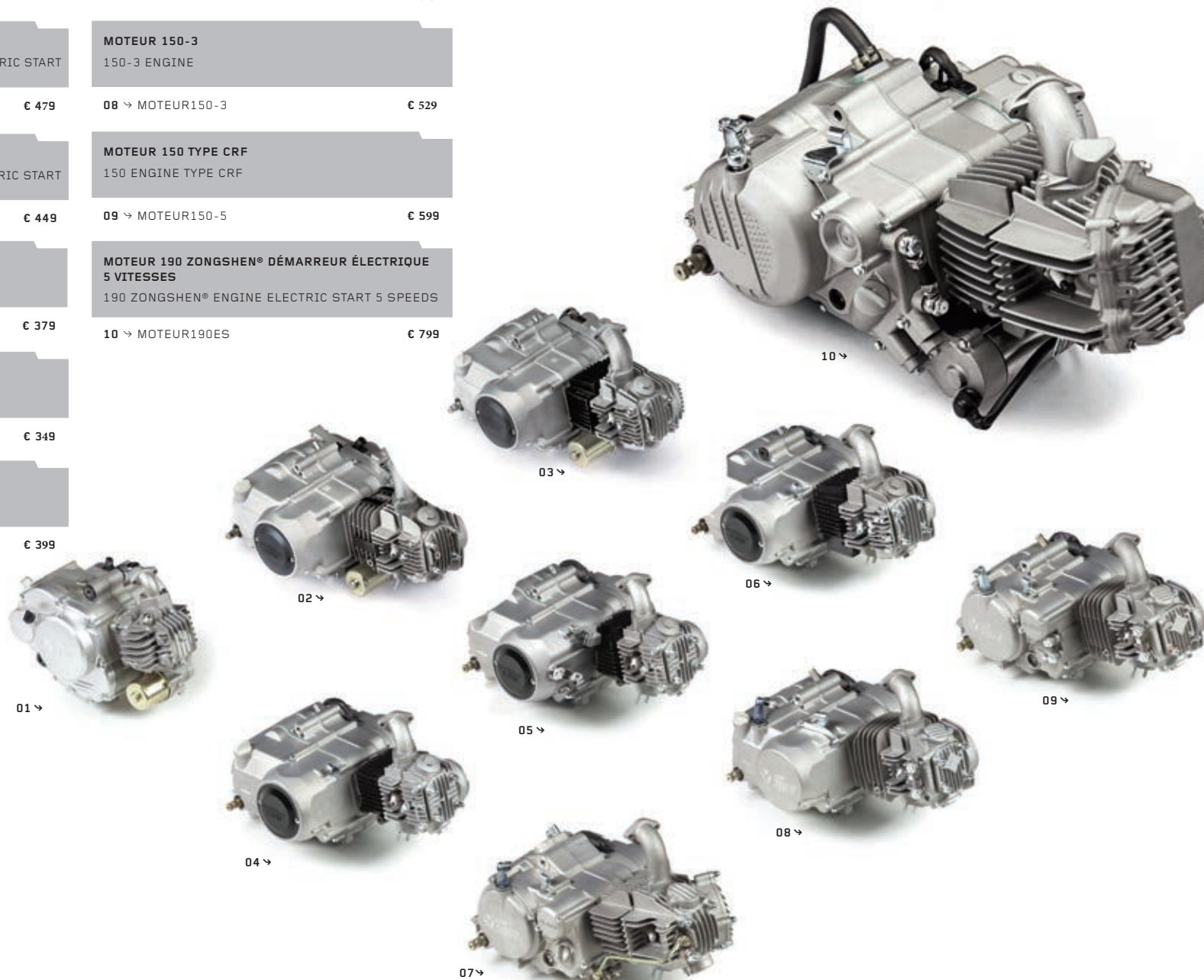

# KITS MOTEUR & PIÈCES ENGINE KITS & PARTS

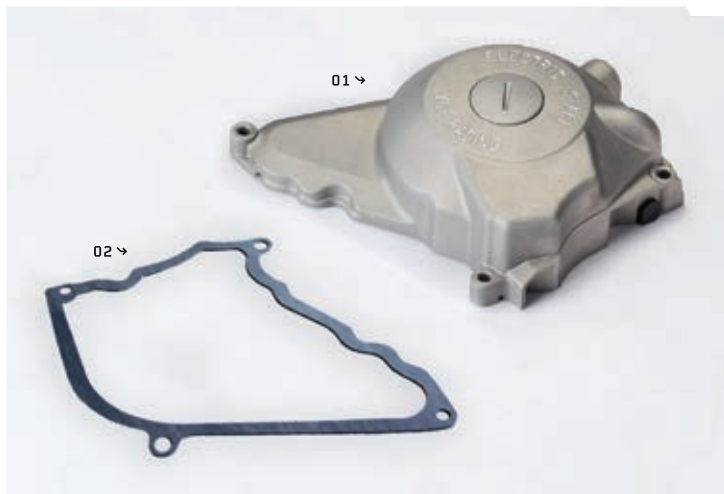

**CARTER D'ALLUMAGE POUR DÉMARREUR ÉLECTRIQUE**  
IGNITION COVER ELECTRIC START

01 → 12301-D083-000189  
02 → 90204-D083-000

€ 39  
€ 4



**CHAÎNE DE DISTRIBUTION**  
TIMING SPROCKET

→ D00F012 (84 MAILLONS POUR 125cc POINT MORT ET SEMI-AUTOMATIQUE/  
84 TEETHS FOR 125cc NEUTRAL START AND SEMI-AUTOMATIC) € 25  
→ 14350 (88 MAILLONS POUR 140cc lifan/ 88 TEETHS FOR 125cc lifan) € 25  
→ 14350/152FMI (90 MAILLONS POUR 125/ 140/ 150 CRF/  
90 TEETHS FOR 125/ 140/ 150 CRF TYPE) € 25  
→ 210F012 (POUR YX 150/ 160 TYPE KLX/ FOR 150/ 160 YX KLX TYPE) € 39



**CARTER D'ALLUMAGE**  
IGNITION COVER

01 → 11411/152FMH (CARTER D'ALLUMAGE/ IGNITION COVER) € 37  
02 → 11411/152FMH-MG (CARTER D'ALLUMAGE/ IGNITION COVER) € 45  
03 → 11411/152FMH-BK (CARTER D'ALLUMAGE/ IGNITION COVER) € 45  
04 → 11419/152FMH (JOINT CARTER ALLUMAGE/ IGNITION COVER GASKET) € 6  
05 → A00-8-1 (CARTER ALLUMAGE LITE 88/125) € 37



**CHAÎNE DE DÉMARREUR**  
STARTER CHAIN

01 → 2141B-IA29-0000 POUR MOTEUR/ FOR ENGINE 88-125 SE € 10  
02 → 100061493 POUR MOTEUR/ FOR ENGINE 190 ZONGSHEN® € 12



**KIT PISTON**  
PISTON KIT

→ KPC/44-13 (YCF 50A) € 59  
→ KPC/47-13 (88 CC Ø 46,5 AXE 13) € 59  
→ KPC/52,5-13 (88/107/120/125 CC Ø 52,5 AXE 13) € 59  
→ KPC/52,5-14 (120/125 CC Ø 52,5 AXE 14) € 59  
→ KPC/54-14 (120/125 CC Ø 54 AXE 14) € 59  
→ KPC/55-15 (140 LIFAN Ø 55 AXE 15) € 59  
→ KPC/56-13 (140/150 YX TYPE CRF Ø 56 AXE 13) € 59  
→ KPC/56,5-15 (150 LIFAN Ø 56,5 AXE 15) € 59  
→ KPC/60-13 (150-160 YX TYPE KLX Ø 60 AXE 13)  
→ KPC/60-13-4V (150 YX 4 V, TYPE KLX Ø 60 AXE 13)  
→ KPC/62-13-4V (160 YX 4 V, TYPE KLX Ø 62 AXE 13) € 62

**JEU DE SEGMENTS SEUL**  
PISTON RINGS SET ONLY

→ 13300F (88 CC Ø 46,5) € 20  
→ 13300/152FMI (107-125 CC Ø 52,5) € 20  
→ 13300/152FMH (125-138 CC Ø 54) € 20  
→ 13300 (140 CC Ø 55) € 20  
→ 208J013 (140-150 CC Ø 56) € 19  
→ 210J013 (150 CC Ø 60)

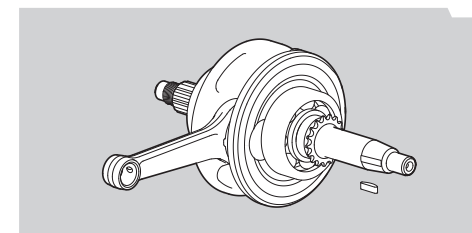

**VILEBREQUIN**  
CRANKSHAFT

→ 13100/152FMI (125 LIFAN AXE PISTON 14)  
→ 208J000 (125/140 YX AXE PISTON 13)  
→ 13100 (140 LIFAN AXE PISTON 15)  
→ 216J000 (150 CRFAXE PISTON 13)  
→ 210J000-2 (150 KLX)  
→ 2043J000 (125 POINT MORT) € 99

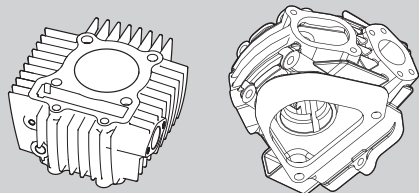

01 ↗

02 ↗

### CYLINDRES & CULASSES

CYLINDERS & CYLINDER HEADS

- 01 ↗ 12110/152FMI (125 LIFAN 52,5mm)
- 01 ↗ 12112 (140 LIFAN 55mm)
- 01 ↗ 206A038 (125 YX 52,5mm)
- 01 ↗ 2081A038 (140 YX 56mm)
- 01 ↗ 208A038 (150 YX TYPE CRF)
- 01 ↗ 210A038 (150 YX TYPE KLX)
- 01 ↗ 204A038 (125 YX 54mm)

€ 99

- 02 ↗ 206A000 (125 YX)
- 02 ↗ 208A000 (140/150 YX TYPE CRF)
- 02 ↗ 210A000 (150/160 YX TYPE KLX)

€ 199

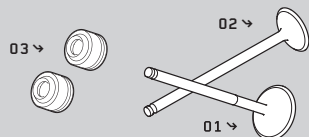

03 ↗

02 ↗

01 ↗

### SOUPAPE D'ADMISSION

INLET VALVE

- 01 ↗ 206F045 (125 YX Ø 24)
- 01 ↗ 14710/152FMI (125, 140, 150 Ø 27)
- 01 ↗ 210F045 (KLX)

€ 19

- 01 ↗ 221F045 (KLX 4V)

€ 39

### SOUPAPE D'ÉCHAPEMENT

EXHAUST VALVE

- 02 ↗ 206F039 (125 YX Ø 21)
- 02 ↗ 14720/152FMI (125, 140, 150 Ø 23)
- 02 ↗ 210F039 (KLX)

€ 19

- 02 ↗ 221F039 (KLX 4V)

€ 39

### JOINT QUEUE SOUPAPE

VALVE STEM SEAL

- 03 ↗ 14730/152FMH

€ 5

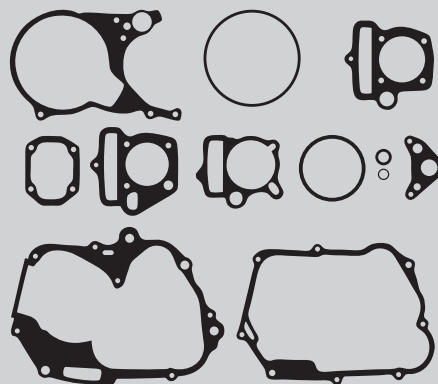

### POCHETTE JOINTS COMPLÈTE

COMPLETE GASKET SET

- ↗ PJCM50 (50 YCF 2010-2011)
- ↗ PJCM50-2 (50 YCF 2011-2021)
- ↗ PJCM88 (88 CC)
- ↗ PJCMSE (START F88SE/ F125SE)
- ↗ PJCM125 (125 CC)
- ↗ PJCM140 (140 CC)
- ↗ PJCM150CRF (150 CC)
- ↗ PJCM150KLX (150 CC TYPE KLX)

€ 29

€ 29

€ 29

€ 29

€ 32

€ 32

€ 32

€ 32



### POCHETTE JOINTS HAUT MOTEUR

GASKET SET TOP END

- ↗ PJHM50 (50 YCF 2010-2011)
- ↗ PJHM50-2 (50 YCF 2011-2021)
- ↗ PJHM88 (88 CC)
- ↗ PJHM125 (125 CC)
- ↗ PJHM140 (140 CC)
- ↗ PJHM150CRF (150 CC)
- ↗ PJHM150KLX (150 CC TYPE KLX)

€ 15

€ 15

€ 15

€ 16

€ 16

€ 16

€ 16

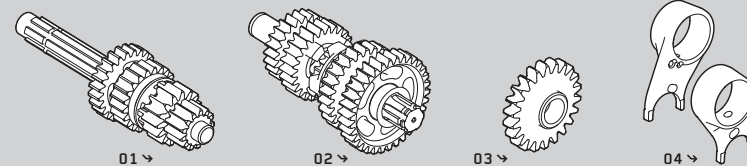

01 ↗

02 ↗

03 ↗

04 ↗

**ARBRE BOÎTE PRIMAIRE COMPLET Ø 12 CÔTÉ ALLUMAGE Ø 14 CÔTÉ EMBR. LIFAN LONG. 155mm/ YX LONG. 153,5mm**  
 COMPLETE MAIN BOX SHAFT Ø 12 IGNITION SIDE & Ø 14 CLUTCH SIDE LIFAN LENGTH 155mm/ YX LENGTH 153,5mm

- 01 ↗ 23600/152FMH (LIFAN)
- 01 ↗ E13K030 (YX)
- 01 ↗ A00K030 (88/ 125 SEMI-AUTO ET 125 POINT MORT)

€ 49

**ARBRE BOÎTE SECONDAIRE COMPLET Ø 17 CÔTÉ PSB LIFAN Ø 14 CÔTÉ ALLUMAGE/ YX Ø 15 CÔTÉ ALLUMAGE**  
 COMPLETE SECONDARY BOX SHAFT Ø 17 PSB SIDE LIFAN Ø 14 IGNITION SIDE/ YX Ø 15 IGNITION SIDE

- 02 ↗ 23700/152FMH (LIFAN)
- 02 ↗ E13K040 (YX)
- 01 ↗ A00K040 (88/ 125 SEMI-AUTO ET 125 POINT MORT)

€ 49

### PIGNON INTERMÉDIAIRE EMBRAYAGE

INTERMEDIATE CLUTCH SPROCKET

- 03 ↗ 208-12-23N (YX : ÉPAISSEUR/ THICKNESS 14mm)

€ 12

### JEU DE FOURCHETTES DE BOÎTE RENFORCÉE

REINFORCED GEARBOX FORK

- 04 ↗ FBR

€ 35

# EMBRAYAGE CLUTCH



**COURONNE D'EMBRAYAGE 88/125 SEMI-AUTO**  
CLUTCH SPROCKET 88/125 SEMI-AUTO

→ 22610L

€ 20



**DISQUE D'EMBRAYAGE YX**  
YX CLUTCH PLATE

01 → 22330/152FMH (GARNI/ FRICTION) € 8  
02 → 22341/152FMH (LISSE/ SMOOTH) € 6



**EMBRAYAGE COMPLET DÉMARRAGE AU POINT MORT**  
START 2012-13  
COMPLETE CLUTCH NEUTRAL START  
START 2012-13

→ EC

€ 60



**EMBRAYAGE COMPLET POUR DÉMARRAGE EN PRISE**  
COMPLETE CLUTCH FOR KICKSTARTER ENGINE

→ 22100/152FMH

€ 89



**EMBRAYAGE COMPLET 88/125 SEMI-AUTO**  
COMPLETE CLUTCH 88/125 SEMI-AUTO

→ 21100L

€ 60



**JOINT SPY SÉLECTEUR**  
OIL SEAL SHAFT

01 → 24190/152FMH

€ 8

**JOINT SPY KICK**  
KICKSTARTER OIL SEAL

02 → F001C015 (KLX: 16X28X7)  
02 → F05C085 (CRF: 16X24X5)  
02 → 27190/152FMH (Ø 13mm) € 7

**JOINT SPY PSB**  
OIL SEAL FOR COUNTERSHAFT SPROCKET

03 → 23790/152FMI (Ø 20 - 20/30/4.5)  
03 → 23790/152FMH (Ø 17 - 17/29/5) € 7

**JOINT SPY TIGE COMMANDE EMBRAYAGE**  
CLUTCH CONTROL OIL SEAL

04 → 22840/152FMH

€ 6

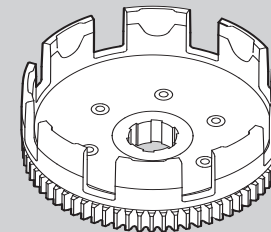

**CLOCHE D'EMBRAYAGE**  
CLUTCH BELL

→ 22110/152FMH

€ 49

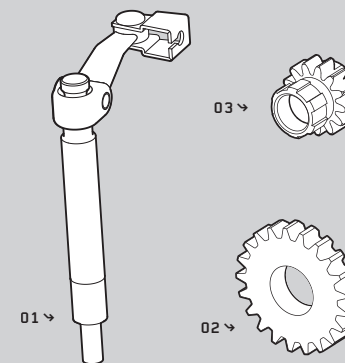

**TIGE COMMANDE EMBRAYAGE**  
PUSH ROD

01 → 22810/152FMH

€ 15

**PIGNON DE KICK**  
KICKSTARTER SPROCKET YX

02 → 27151/152FMH (LIFAN)  
02 → 208K025 (YX) € 12

**PIGNON CLOCHE EMBRAYAGE**  
CLUTCH BELL SPROCKET

03 → 27231/152FMH (LIFAN)  
03 → 208-12-25 (YX) € 12





**CARTER D'EMBRAYAGE (125CC)**  
CLUTCH COVER FOR 125CC ENGINE

- D01A034-EC (125 P) € 59
- 11310/1P52FMK (SEMI-AUTO) € 59
- 11310/152FMI (DÉMARAGE EN PRISE) € 59



**CARTER EMBRAYAGE 150 TYPE CRF OU KLX**  
CLUTCH COVER 150 TYPE CRF OR KLX

- 216A034 (TYPE CRF KICK Ø 16) € 99
- 2103A034 (TYPE KLX KICK Ø 16) € 99



**DEMI CARTER EMBRAYAGE 88/ 125**  
HALF CLUTCH COVER 88/ 125

- RCSC-BK € 25

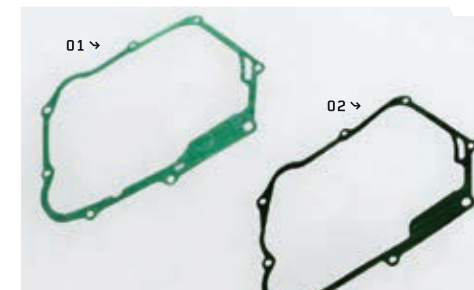

**JOINTS DE CARTER D'EMBRAYAGE**  
ENGINE CLUTCH COVER GASKET

- E041B002 (START/ PILOT 125) € 6
- 11319/152FHM (125 - 140 - 150CRF) € 6



**↙ KITS DRESS UP  
DRESS UP KITS**

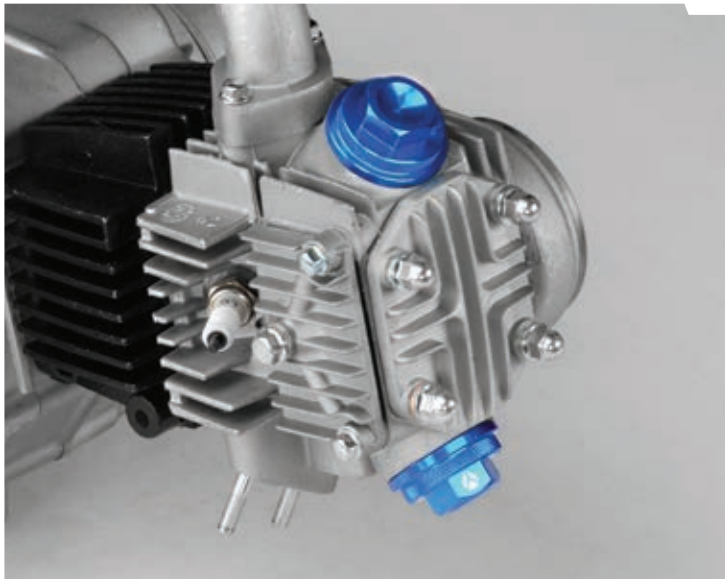

**FACTORY**  
SPECIAL PARTS  
YCF RACING

PAIRE DE CACHE SOUPAPE POUR 88/ 125 SEMI-AUTO/ 125 POINT MORT  
ROUGE/ BLEU/ NOIR/ ORANGE/ VERT  
PAIR OF VALVE COVER 88/ 125  
RED/ BLUE/ BLACK/ ORANGE/ GREEN

→ VC88 + COLOR (X2)

€ 29



**FACTORY**  
SPECIAL PARTS  
YCF RACING

CACHE FILTRE À HUILE POUR 150 CRF/ KLX  
ROUGE/ BLEU/ NOIR/ ORANGE/ VERT  
OIL FILTER COVER 150 CRF/ KLX TYPE  
RED/ BLUE/ BLACK/ ORANGE/ GREEN

→ OFCCRF + COLOR

€ 29



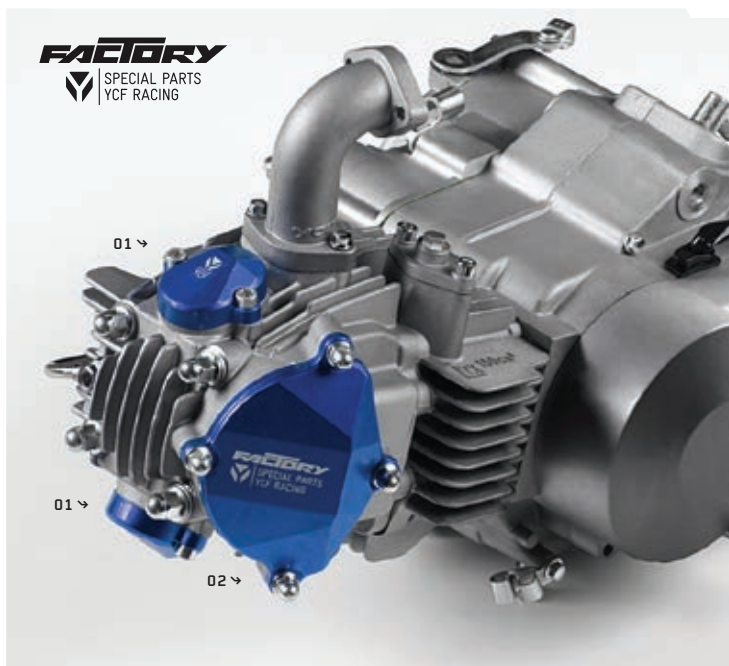

**PAIRE DE CACHES SOUPAPE KLX 150**  
**ROUGE/ BLEU/ NOIR/ ORANGE/ VERT**  
 PAIR OF VALVE COVER KLX 150  
 RED/ BLUE/ BLACK/ ORANGE/ GREEN

01 → VCKLX + COLOR

€ 29

**CACHE CULASSE KLX 150**  
**ROUGE/ BLEU/ NOIR/ ORANGE/ VERT**  
 CYLINDER HEAD COVER KLX 150  
 RED/ BLUE/ BLACK/ ORANGE/ GREEN

02 → CAMCKLX + COLOR

€ 25



**CACHE YX/ LIFAN**  
**ROUGE/ BLEU/ NOIR/ ORANGE/ VERT**  
 COVER YX/ LIFAN  
 RED/ BLUE/ BLACK/ ORANGE/ GREEN

01 → CAMC + COLOR

€ 25

**CACHE CDI YX/ LIFAN**  
**ROUGE/ BLEU/ NOIR/ ORANGE/ VERT**  
 CDI COVER YX/ LIFAN  
 RED/ BLUE/ BLACK/ ORANGE/ GREEN

02 → CDIC + COLOR

€ 25

# CARBURATEURS CARBURETORS

**NIBBI**

**NEW  
2021**



## CARBURATEUR NIBBI NIBBI CARBURETOR

- 01 → PE18FL POUR MOTEUR 88cc € 59
- 02 → PE19FL POUR MOTEUR 125/150cc € 59  
→ PE24SP (SM125/SM150) € 59
- 03 → PE28SP POUR MOTEUR 190cc € 119

**GICLEUR NIBBI CARBURATEUR PE GICLEUR PRINCIPAL / MAIN JET 88/90/92/95/98/100/102/105/108/110/112/115/118/120/122/125/128/130/132/135**

04 → LK-PE + TAILLE/ SIZE € 7

**GICLEUR NIBBI CARBURATEUR PWK GICLEUR PRINCIPAL / MAIN JET 98/100/102/105/108/110/112/115/118/120/122/125/128/130/132/135/138/140/142/145/148**

05 → LK-PWK + TAILLE/ SIZE € 7

**GICLEUR NIBBI CARBURATEUR PZ GICLEUR PRINCIPAL / MAIN JET 70/72/75/78/80/82/85/88/90/92/95/98/100**

06 → LK-PZ + TAILLE/ SIZE € 7

**GICLEUR NIBBI CARBURATEUR PE/PWK GICLEUR RALENTI / SLOW JET 30/32/35/38/40/42/45/48/50/52/55**

07 → LK-FLK + TAILLE/ SIZE € 7

**GICLEUR NIBBI CARBURATEUR PZ GICLEUR RALENTI / SLOW JET 30/32/35/38/40**

08 → LK-FLKZ + TAILLE/ SIZE € 7



## CARBURATEUR YCF 50 YCF 50 CARBURETOR

→ YC50-20-31

€ 69



## CARBURATEUR KEIHIN® PE28mm PE28mm KEIHIN® CARBURETOR

→ 85707

€ 179

**MIKUNI**

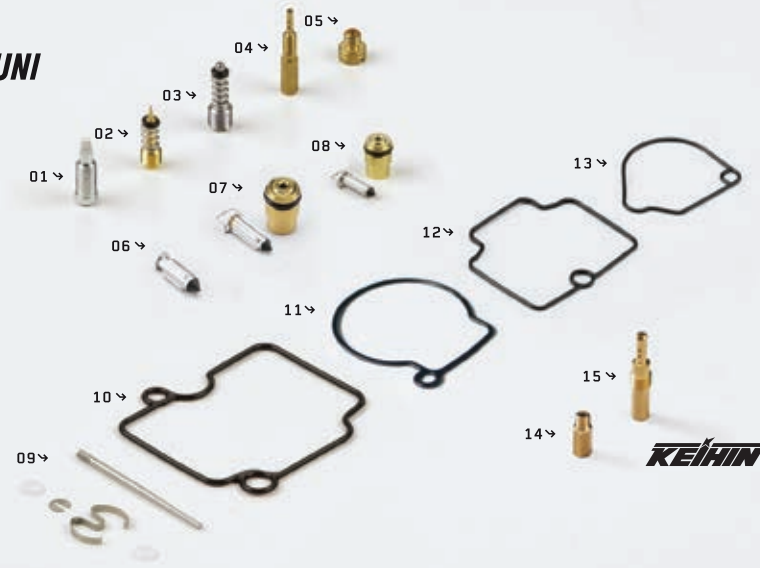

## VIS DE CUVE MIKUNI® MIKUNI® TANK SCREW

01 → 16007L

€ 7

## VIS RICHESSE + RESSORT MIKUNI® MIKUNI® NEEDLE VALVE + SPRING

02 → 16005L

€ 7

## VIS RALENTI + RESSORT MIKUNI® MIKUNI® IDLE SCREW + SPRING

03 → 16006L

€ 7

## GICLEUR RALENTI MIKUNI® 10/ 15/ 17,5/ 20/ 22,5/ 25 MIKUNI® SLOW JET

04 → GICLEUR + TAILLE/ SIZE

€ 7

**GICLEUR PRINCIPAL MIKUNI® 85/ 90/ 92,5/ 95/ 97,5/ 100/ 102,5/ 105/ 107,5/ 110/ 115/ 120**  
MIKUNI® MAIN JET

05 → GICLEUR + TAILLE/ SIZE

€ 7

## POINTEAU CARBURATEUR CARBURETOR FLOAT NEEDLE

06 → FLON-50A (YCF50A)

07 → FLON-CARBU22 (MIKUNI® 22)

08 → 16008L (MIKUNI® 26)

€ 12

## AIGUILLE CARBURATEUR MIKUNI® MIKUNI® CARBURETOR NEEDLE

09 → 16004L

€ 12

## JOINT CUVE CARBURATEUR CARBURETOR FLOAT BOWL GASKET

10 → 16010L (MIKUNI® 26)

11 → SEAL-CARBU22 (MIKUNI® 22)

12 → SEAL-PE28 (KEIHIN® PE28)

13 → SEAL-50A (YCF 50A)

€ 5

**GICLEUR PRINCIPAL KEIHIN® 115/ 118/ 120/ 122/ 125/ 128/ 130/ 132**  
KEIHIN® MAIN JET

14 → 99101-357 + TAILLE/ SIZE

€ 8

**GICLEUR RALENTI KEIHIN® 35/ 38/ 40/ 42/ 45/ 48**  
KEIHIN® SLOW JET

15 → N424-21 + TAILLE/ SIZE

€ 8



**PIPE ADMISSION DAYTONA®**  
DAYTONA® INLET PIPE

- |                    |      |
|--------------------|------|
| 01 ↪ 86404 (ANIMA) | € 19 |
| ↪ 86387 (DT)       | € 25 |

**PIPE ADMISSION POUR BOÎTE À AIR**  
INLET PIPE FOR AIRBOX

- |            |      |
|------------|------|
| 02 ↪ 17311 | € 16 |
|------------|------|

**PIPE ADMISSION POUR BOÎTE À AIR**  
INLET PIPE FOR AIRBOX

- |  |      |
|--|------|
| 03 ↪ 17311-2 (POUR/ FOR FACTORY SPII)  | € 15 |
| 03 ↪ 17311-4 (POUR/ FOR PILOT 125)     | € 15 |
| 03 ↪ 17311-5 (POUR/ FOR PILOT 150)     | € 15 |
| 03 ↪ 17311-6 (POUR/ FOR PE28)          | € 19 |
| 03 ↪ 17311-3 (POUR/ FOR FACTORY SPIII) | € 19 |

**JOINT PAPIER PIPE ADMISSION**  
INLET PIPE PAPER GASKET

- |   |        |
|---|--------|
| 04 ↪ 17332/152FMH01 (ENTRE LA PIPE D'ADMISSION ET LE CARBURATEUR/<br>BETWEEN INLET PIPE AND CARBURETOR) | € 2,50 |
| 04 ↪ 17332 (ENTRE LA CULASSE ET LA PIPE D'ADMISSION/<br>BETWEEN CYLINDER HEAD AND INLET PIPE)           | € 2,50 |

**CALE PLASTIQUE PIPE ADMISSION**  
INLET PIPE PLASTIC HOLDER

- |                   |     |
|-------------------|-----|
| 05 ↪ 17331/152FMH | € 6 |
|-------------------|-----|



↪ FOR 50 ONLY



**STARTER AU GUIDON POUR YCF50A**  
CHOKE LEVER FOR YCF50A

- |                   |      |
|-------------------|------|
| 01 ↪ YC50-0142-01 | € 19 |
|-------------------|------|

01 ↪

02 ↪

**MANCHON SOUPLE**  
FLEXIBLE SLEEVE

- |                                 |      |
|---------------------------------|------|
| 01 ↪ 17315 (VM 24)              | € 29 |
| 02 ↪ 46758 (POUR/ FOR DAYTONA®) | € 32 |



# FILTRES À AIR AIR FILTERS



**SURFILTRE À AIR (VENDU SANS FILTRE À AIR)**  
AIR FILTER PROTECTION (SELL WITHOUT AIR FILTER)

- K130K (POUR FILTRE ORIGINE YCF/ FOR YCF ORIGINAL AIR FILTER)
- K386K (POUR/ FOR TWIN AIR)

€ 19



**CAGE DE FILTRE À AIR**  
AIR FILTER CAGE

- 01 → YC110-08-012
- 02 → YC110-08-013

€ 6  
€ 10

**MANCHON DE BOÎTE À AIR YCF**  
YCF AIRBOX SLEEVE

- 03 → YC110-08-0171 (Ø 49 POUR/ FOR KEHIN® PE28)
- 03 → YC110-08-017 (Ø 40)
- 03 → YC110-08-0173 (PILOT 125 2015-2020)
- 03 → YC110-08-0174 (PILOT 150 2016-2020/ SM150 2016-2020)

€ 10



**FILTRE À AIR MOUSSE**  
FOAM AIR FILTER

- 01 → TA-158430 (POUR/FOR AIR BOX PILOT/ FACTORY/ BIGY) € 20
- 02 → TA-158432 (Ø 40mm POUR/ FOR MIKUNI® 26mm) € 25
- 03 → TA-158431 (Ø 50mm POUR/ FOR KEIHIN® 28mm) € 25



→ PIPE ADMISSION ADÉQUATE, VOIR PAGE 125  
→ SUITABLE INLET PIPE, CHECK PAGE 125

**BOÎTE À AIR**  
AIRBOX

- 01 → YC110-0801-07 (POUR/ FOR PILOT 125 & 150, 2015-21) € 49
- 02 → YC110-08-02 (POUR/ FOR FACTORY 2012-21)
- 03 → YC110-0801-09 (POUR/ FOR LITE/ START)



**FILTRE À AIR MOUSSE**  
FOAM AIR FILTER

- 01 → YC110-0802-03 (POUR/ FOR CARBU 22 mm)  
(POUR FOR LITE/ START 88) € 22
- 02 → YC110-0802-10 (POUR/ FOR CARBU 26MIKUNI/  
NIBBI PE19FL/ PE24SP)(POUR FOR LITE/ START  
125/ SM 125/150) € 22
- 03 → YC110-0802-05 (POUR/ FOR CARBU KEIHIN/  
NIBBI PE 28 mm ) € 24



**FILTRE À AIR EN MOUSSE POUR BOÎTE À AIR**  
FOAM AIR FILTER FOR AIR BOX

- YC110-0817-03  
(PILOT 2016-21/ FACTORY 2012-21/ BIGY) € 15

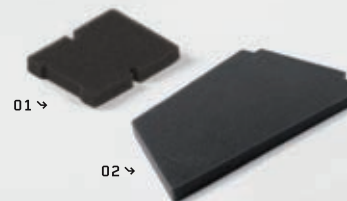

**FILTRE À AIR EN MOUSSE POUR BOÎTE À AIR**  
FOAM AIR FILTER FOR AIR BOX

- 01 → YC50-0802 (POUR/ FOR YCF 50) € 6
- 02 → YC110-0817-02 (POUR/ FOR LITE/ START) € 12



# ÉCHAPPEMENTS RACING RACING EXHAUSTS



**FACTORY**  
SPECIAL PARTS  
YCF RACING

**LIGNE ÉCHAPPEMENT COMPLETE RACING SIMPLE**  
COMPLETE RACING EXHAUST SINGLE

- YC110-136-07-BK (POUR/ FOR PILOT/ SM150)
- YC110-139-07-BK (POUR/ FOR FACTORY)
- YC110-140-01-BK (POUR/ FOR BIGY)

€ 299



**EMBOUIT DE POT FACTORY**  
FACTORY EXHAUST END

→ YC110-13-35

€ 19



**RESSORT DE POT FACTORY**  
FACTORY EXHAUST SPRING WITH RUBBER

→ YC110-13-22

€ 3



**FACTORY**  
SPECIAL PARTS  
YCF RACING

**SILENCIEUX RACING FACTORY**  
FACTORY RACING EXHAUST

→ YC110-13014-03BK

€ 149



**FACTORY**  
SPECIAL PARTS  
YCF RACING

**ATTACHE SILENCIEUX FACTORY**  
FACTORY MUFFLER CLAMP

→ YC110-1307-03

€ 19



**FACTORY**  
SPECIAL PARTS  
YCF RACING

**LIGNE ÉCHAPPEMENT COMPLETE RACING DOUBLE**  
COMPLETE RACING EXHAUST TWIN

- YC110-136-08-BK (POUR/ FOR PILOT/ SM150)
- YC110-139-08-BK (POUR/ FOR FACTORY)
- YC110-140-02-BK (POUR/ FOR BIGY)

€ 399



**COLLECTEUR RACING**  
RACING MID PIPE

- YC110-1302-22 (PILOT) € 89
- YC110-1302-13 (SP3) € 89
- YC110-1308-01 (BIGY) € 89



**Y DU COLLECTEUR RACING DOUBLE**  
DOUBLE RACING MID PIPE Y

- YC110-1302-23 (PILOT) € 79
- YC110-1302-14 (SP)
- YC110-1308-03 (BIGY)



**PARTIE INTERMÉDIAIRE COLLECTEUR RACING**  
RACING MID PIPE INTERMEDIATE PART

- YC110-1302-24 (PILOT) € 39
- YC110-1302-15 (SP)
- YC110-1308-02 (BIGY)



**ÉCHAPPEMENT YCF ANTI-BRUIT (GAMME FACTORY)**  
SPARK ARESTOR YCF EXHAUST (FACTORY RANGE)

- YC110-139-03 (POUR/ FOR FACTORY SP2 & SP3) € 249
- YC110-139-09 (POUR/ FOR BIGY)



**COLLECTEUR ÉCHAPPEMENT FACTORY**  
FACTORY EXHAUST MID PIPE

- YC110-13028-01 (SP3) € 119
- YC110-13028-03 (BIGY 190) € 119
- YC110-13028-05 (PILOT) € 119
- YC110-13028-02 (SP3 DOUBLE) € 149
- YC110-13028-04 (BIGY DOUBLE) € 149
- YC110-13028-06 (PILOT DOUBLE) € 149



**ÉCHAPPEMENT GROS DIAMÈTRE AVEC BRIDE DE POT AMOVIBLE**  
LARGE DIAMETER EXHAUST SUPPLIED WITH REMOVABLE SPARK ARRESTOR

- YC110-136-GY (POUR/ FOR START) € 99
- YC110-136-03-GY (POUR/ FOR PILOT/ SM 150)
- YC110-139-10 (POUR/ FOR BIGY)



**COLLECTEUR ÉCHAPPEMENT BIGY**  
BIGY EXHAUST MID PIPE

- YC110-1302-20 (125/150 BIGY MX) € 59
- YC110-1302-26 (190 BIGY ZE)
- YC110-1302-28 (150 BIGY FACTORY)

## FILTRES & RADIATEURS FILTERS & COOLERS



**KIT COMPLET RADIATEUR HUILE**  
COMPLETE OIL COOLER KIT

- YC110-2302 (YX 150 TYPE KLX DIAM 10/10)
- YC110-2307 (DAYTONA®/ YX TYPE CRF)
- YC110-2305 (AFTERMARKET DIAM 10/10)

€ 119



**KIT RADIATEUR UNIVERSEL ADAPTABLE SUR TOUS LES MODÈLES**  
UNIVERSAL OIL COOLER KIT ADAPTABLE TO ALL MODELS

- YC110-2306 (VENDU AVEC 6 DURITES/ SOLD WITH 6 HOSES)

€ 199

**NEW  
2021**



**PETITE JAUGE HUILE BLEU/ ROUGE/ ORANGE/ NOIR/ VERT**  
LITTLE OIL DIPSTICK BLUE/ RED/ ORANGE/ BLACK/ GREEN

- 01 → JH01 (SM150/ FACTORY/ BIGY FACTORY 150/190) € 17



**FILTRE À HUILE**  
OIL FILTER

- 01 → 216E010 € 18

**ÉPURATEUR D'HUILE ALLÉGÉ**  
FLYWHEEL

- 02 → 208G082 € 25



**DURITE HUILE RADIATEUR**  
OIL COOLER HOSE

- YC110-23-01 (2007)
- YC110-23-013 (L=400MM)
- YC110-23-014 (L=285MM/ Ø=10)
- YC110-23-015 (L=260MM/ Ø=8/8)
- YC110-23-016 (L=125MM/ Ø=10/8)
- YC110-23-017 (L=290MM/ Ø=10/10)
- YC110-23-0003 (L=110MM/ Ø=10/8)
- YC110-23-02 (2007)
- YC110-23-022 (L=490MM)
- YC110-23-023 (L=395MM/ Ø=10/8)
- YC110-23-024 (L=495MM/ Ø=10/8)
- YC110-23-025 (L=360MM/ Ø=10/10)

€ 19

**SPECIAL PARTS  
YCF RACING**



**JAUGE HUILE ROUGE/ NOIRE/ BLEUE/ ORANGE/ VERTE**  
OIL DIPSTICK RED/ BLACK/ BLUE/ ORANGE/ GREEN

- JH + COLOR (LITE/ START/ PILOT/ BIGY 125/150 MX) € 17

**SPECIAL PARTS  
YCF RACING**



**BOUCHON VIDANGE AIMANTÉ**  
ROUGE/ BLEU/ NOIR/ ORANGE/ VERT  
MAGNETIC DRAIN PLUG  
RED/ BLACK/ BLUE/ ORANGE/ GREEN

- 01 → BVE1 + COLOR € 15

**HUBLOT À HUILE**  
OIL LEVEL SIGHT GLASS

- 02 → D00C027 € 15





# ALLUMAGE IGNITION



## FAISCEAU ÉLECTRIQUE WIRING HARNESS

- 01 → YC110-1501 (NON ÉTANCHANCHE/ NO WATERPROOF)  
→ YC110-1501-12 START SE 88/125 (CONNECTEUR ÉTANCHE/ WATERPROOF CONNECTION) € 15
- YC110-1501-08 BIGY (DÉMARREUR ÉLECTRIQUE/ ÉLECTRIC START/ CONNECTEUR ÉTANCHE/ WATER-PROOF CONNECTION) € 19
- YC110-1501-09 BIGY (SANS DÉMARREUR/ WITHOUT ÉLECTRIC START CONNECTEUR ÉTANCHE/ WATERPROOF CONNECTION) € 19
- YC110-1501-11 (LITE/START/PILOT/SP) (SANS DÉMARREUR/ WITHOUT ÉLECTRIC START CONNECTEUR ÉTANCHE/ WATERPROOF CONNECTION) € 15

## BOÎTIER CDI CDI BOX

- 02 → YC110-1503 € 15

## BOBINE HAUTE TENSION HIGH TENSION IGNITION COIL

- 03 → YC110-1504 € 15

## BATTERIE BATTERY

- 04 → YC110-1507-02 (88 & 125SE) € 35
- 04 → YC110-1507-04 (190ZE) € 39



## CDI RACING CDI RACING

- YC110-1503-01 € 29



## ALLUMAGE YCF 50A YCF 50A IGNITION

- 01 → YC50-0021 (CONTACTEUR CLÉ/ KEY SWITCH) € 10
- 02 → YC50-1502 (RÉGULATEUR DE TENSION/ TENSION REGULATOR) € 15
- 03 → YC50-1510 (RELAIS DÉMARREUR/ STARTER RELAY) € 15
- 04 → YC50-1507-01 (BATTERIE POUR 50A/ BATTERY FOR 50A) € 35
- 05 → YC50-1514 (CHARGEUR BATTERIE/ BATTERY CHARGER) € 35
- 06 → YC110-0021-02 (CONTACTEUR CLÉ ÉTANCHE/ WATERPROOF KEY SWITCH) € 15
- B2200-D083-000151 (DÉMARREUR 88/ 125SE) € 59
- YC50-20-66 (DÉMARREUR 50A) € 59



## ALLUMAGE MAGNETO

- 01 → RRG (ALLÉGÉ/ LIGHTWEIGHT) € 99
- 02 → 31100/152FMH € 39
- 03 → 31210/152FMH (PRISE ÉTANCHE) € 39
- 82120-G011-30534 (START SE) € 35





**COUPE CIRCUIT**  
REMOTE SWITCH

- 01 → YC110-0105-01 (SWITCH ON/OFF) € 15
- 02 → YC110-0105 (SWITCH) € 20
- 03 → YC110-0105-16 (SWITCH-WATERPROOF) € 20
- 04 → YC110-0105-05 (SWITCH + LEASH) € 20

**COMPTEUR D'HEURE & SUPPORT**  
HOUR METER & SUPPORTING PLATE

- 05 → STANDCOMPT-H (SUPPORT/ SUPPORTING PLATE) € 9
- 06 → COMPT-H (COMPTEUR D'HEURE/ HOUR METER) € 29
- 07 → COMPT01-H (COMPTEUR D'HEURE VIBRATION/ HOUR METER VIBRATION) € 39



**COUPE CIRCUIT À DISTANCE**  
VENDU AVEC 2 TÉLÉCOMMANDES  
DISTANCE ENGINE CUT OFF  
SOLD WITH 2 REMOTES CONTROL

→ YC50-1518 € 79



**BOUGIE & ANTI PARASITE**  
SPARK PLUG & SPARK PLUG CAP

- 01 → 221D021 (4 SOUPAPES YX/ YX 4 STROKE) € 39
- 02 → 34210/152FMH (CR7HS) € 8
- 03 → 34210/D8EA (D8EA 125 R START 2012-13)
- 04 → YC110-1505 (CAP/ ANTI PARASITE) € 6



# DAYTONA® ANIMA® RACING PARTS / PIÈCES RACING



**CHAÎNE DE DISTRIBUTION RENFORCÉE D.I.D**  
D.I.D REINFORCED TIMING SPROCKET

→ 87577 € 65



**PISTON FORGÉ POUR ANIMA®**  
FORGED PISTON FOR ANIMA®

→ 87173 (150cc) € 99  
→ 88599 (190cc) € 109



**KIT ARBRE À CAME RACING**  
RACING CAMSHAFT KIT

→ 87583 € 249

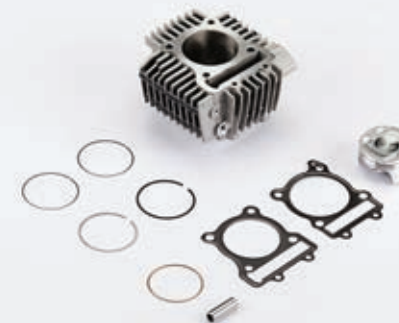

**KIT 212cc**  
212cc KIT

→ 88011 € 319  
→ 88976 € 79



**KIT ALLUMAGE F-SM RÉGLABLE**  
MULTI CURVES ROTOR KIT

→ 87235 € 249



**NEW  
2021**

**COUVRE FILTRE HUILE ANIMA® BLEU/ ROUGE/  
ORANGE/ NOIR/ VERT**  
ANIMA® OIL FILTER COVER BLUE/ RED/ ORANGE  
BLACK/ GREEN

→ OFCDAYT-COLOR € 25



**COUVRE CULASSE ANIMA® RACING**  
ANIMA® RACING CYLINDER HEAD COVER

→ 87994 € 49



**PIPE ADMISION ANIMA® 15°**  
INTAKE MANIFOLD ANIMA® 15°

→ 88253 € 49



**CHAÎNE DE DÉMARREUR RENFORCÉE DID**  
STARTER CHAIN DID

→ 89522 € 45

# DAYTONA®

# DAYTONA® ANIMA® 2,0 150/190cc (4 VALVES) GENUINE PARTS/ PIÈCES D'ORIGINES

DAYTONA

SEQ #	PART #	DESCRIPTION	QTY	(€) UNIT PRICE
1	86461	BOLT, CROSS RECESSED COUNTERSUNK M6x15	2	1,00
2	86464	BOLT, HEXAGON FLANGE M6x25	2	1,00
3	86472	BOLT, HEXAGON FLANGE M6x32	1	1,00
4	86427	BOX, CDI, DESIGNATION FDX	1	119,00
4	88130	BOX, CDI FSM (12900 RPM MAX)	1	69,00
5	86426	COIL, IGNITION	1	15,00
6	86373	COVER, MAGNET	1	39,00
7	86431	FLYWHEEL MAGNET COMP FDX	1	79,00
7	88127	FLYWHEEL MAGNET COMP FSM	1	65,00
8	86452	NUT, MAGNET M12	1	2,00
9	86479	O-RING, Ø6,5xØ1,8	2	2,00
10	86430	STATOR ASSY, DESIGNATION FDX	1	89,00
10	88129	STATOR ASSEMBLY FSM	1	65,00
11	86428	WIRE HERNESS	1	39,00

DAYTONA

SEQ #	PART #	DESCRIPTION	QTY	(€) UNIT PRICE
1	84678	BOLT, CROSS RECESSED COUNTERSUNK M6x30	1	1,00
2	84677	BOLT, CROSS RECESSED COUNTERSUNK M6x35	2	1,00
3	84676	GASKET, PUMP OIL	1	1,00
4	83747	PIN, DOWEL Ø8xØ6,3x12	2	1,00
5	86382	PUMP, OIL ASSY	1	49,00

DAYTONA

SEQ #	PART #	DESCRIPTION	QTY	(€) UNIT PRICE
1	86446	BOLT, BANJO M10x22,5	2	3,00
2	86362	BOLT, HEXAGON FLANGE M6x105	1	2,00
3	86486	BOLT, HEXAGON FLANGE M6x15	2	3,00
4	86469	BOLT, HEXAGON FLANGE M6x22	2	1,00
5	86485	BOLT, HEXAGON FLANGE M6x28	2	2,00
6	86471	BOLT, HEXAGON FLANGE M6x30	2	1,00
7	86473	BOLT, HEXAGON FLANGE M6x50	2	2,00
8	86474	BOLT, HEXAGON FLANGE M6x55	1	2,00
9	83759	BOLT, HEXAGON FLANGE M6x60	1	2,00
10	86361	BOLT, HEXAGON FLANGE M6x90	1	2,00
11	86376	COVER, CLUTCH	1	120,00
12	86374	COVER, OIL FILTER	1	12,00
13	86377	COVER, SMALL CLUTCH	1	59,00
14	83489	FILTER, OIL	1	16,00
15	86437	GASKET, COVER CLUTCH	1	10,00
16	86476	GASKET, M10	4	2,00
17	86412	HOLDER, CABLE CLUTCH	1	9,00
18	86414	LEVER, CLUTCH COMP	1	35,00
19	86432	O-RING, Ø38,6x2,6	1	2,00
20	86435	O-RING, COVER SMALL CLUTCH	1	5,00
21	86441	OIL SEAL, Ø16xØ26x7	1	5,00
22	86442	OIL SEAL, Ø17xØ10x5	1	3,00
23	86406	OIL THROUGH COMP	2	19,00
24	83747	PIN, DOWEL Ø8xØ6,3x12	4	1,00
25	86386	RULER	1	3,00
26	86413	SPRING, LEVER CLUTCH	1	2,00
27	86375	SPRING, OIL FILTER	1	2,00
28	86475	WINDOW, OIL LEVEL	1	15,00

DAYTONA



## ALLUMAGE GENERATOR

ANIMA® 2,0 150/ 190CC

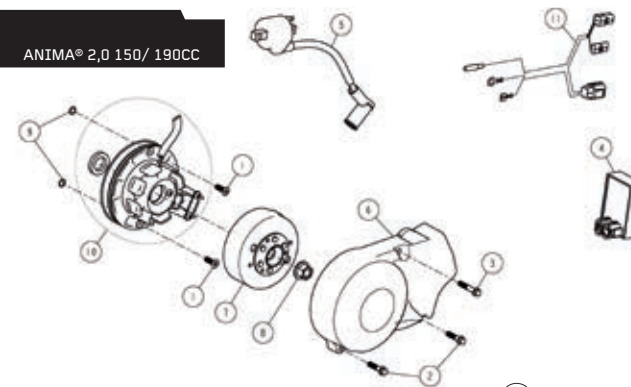

DAYTONA



## POMPE À HUILE OIL PUMP

ANIMA® 2,0 150/ 190CC

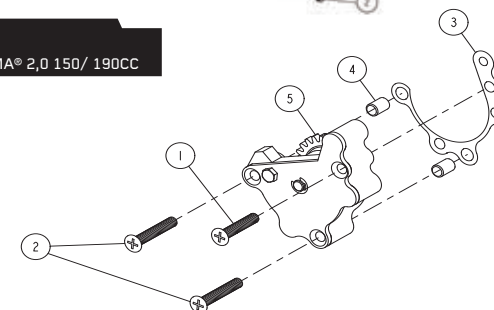

DAYTONA



## CARTER EMBRAYAGE COVER CLUTCH

ANIMA® 2,0 150/ 190CC

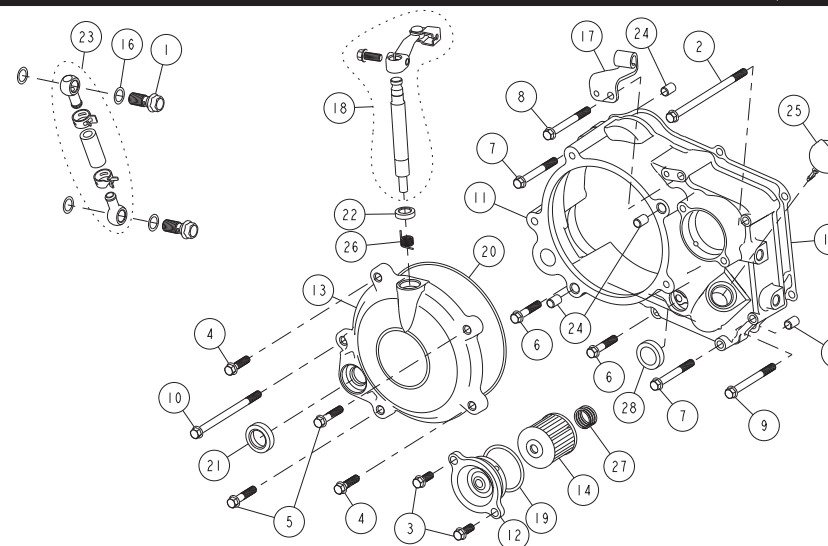

DAYTONA

SEQ #	PART #	DESCRIPTION	QTY	(€) UNIT PRICE
1	86453	CLIP, PIN PISTON	2	2,00
2	86381	CRANK SHAFT ASSY ANIMA 150	1	199,00
3	86620	CRANK SHAFT ASSY ANIMA 190	1	199,00
3	87760	CRANK SHAFT ASSY ANIMA 160	1	199,00
3	89144	CRANK SHAFT ASSY ANIMA 190-5 SPEEDS	1	229,00
4	86383	GEAR, OIL PUMP DRIVE	1	15,00
5	86415	GEAR, PRIMARY DRIVE	1	29,00
6	83768	NUT, SMALL M14	1	3,00
7	86443	OIL SEAL, Ø12xØ20x5t	1	6,00
8	86379	PIN, PISTON Ø14	1	5,00
9	86378	PISTON DT150	1	59,00
10	86621	PISTON DT190	1	65,00
11	86462	RETAINING RING, RTWN22	1	2,00
12	86380	RING SET, PISTON	1	30,00
13	86411	WASHER, SPRING	1	3,00

DAYTONA

PISTON & VILEBREQUIN  
PISTON & CRANCK SHAFT

ANIMA® 2,0 150/ 190CC

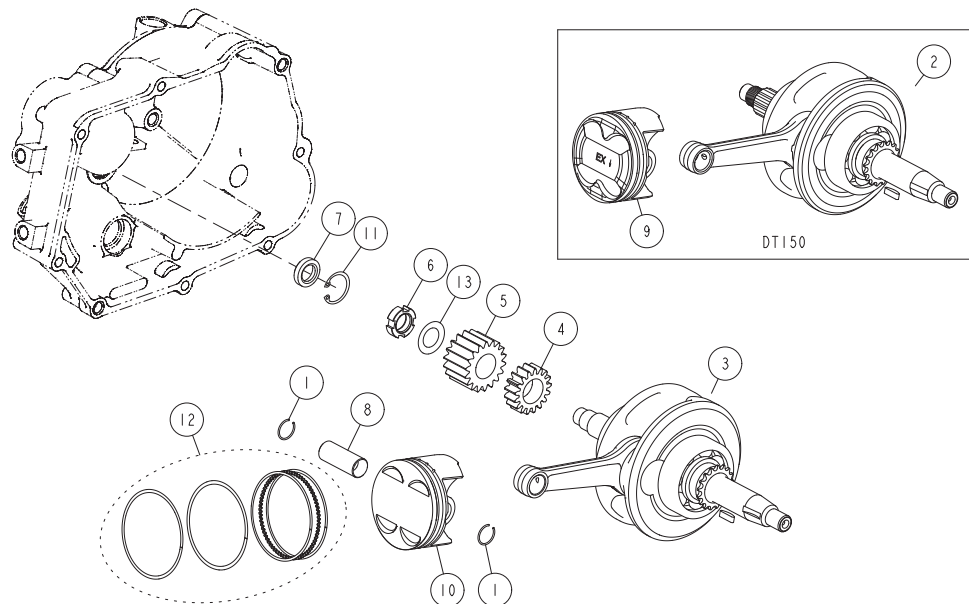

DAYTONA

SEQ #	PART #	DESCRIPTION	QTY	(€) UNIT PRICE
1	86474	BOLT, HEXAGON FLANGE M6x55	1	2,00
2	83761	BOLT, HEXAGON FLANGE M6x65	1	2,00
3	86360	BOLT, HEXAGON FLANGE M6x70	5	2,00
4	86459	BOLT, HEXAGON SOCKET M6x105	2	3,00
5	83755	BOLT, OIL DRAIN M12x15	1	2,00
6	86444	BOLT, STUD A	2	6,00
7	86445	BOLT, STUD B	2	6,00
8	86369	COVER, STRAINER OIL	1	4,00
9	86370	CRANK CASE, LH	1	119,00
9	89143	CRANK CASE, LH, 5 SPEEDS	1	149,00
10	86884	CRANK CASE, RH	1	109,00
10	88848	CRANK CASE, RH, 5 SPEEDS	1	119,00
11	86438	GASKET, CRANKCASE	1	6,00
12	86371	HOSE, BREATHER	1	10,00
13	86451	NUT FLANGE, M8	4	1,00
14	86433	O-RING, Ø30xØ3	1	2,00
15	83720	PIN, DOWELØ10xØ8,4x14	2	2,00
16	86385	SPRING, STRAINER	1	1,00
17	86387	STRAINER, OIL	1	3,00
18	86457	WASHER, GASKET M8	4	2,00
19	83754	WASHER, OIL DRAIN M12	1	5,00

DAYTONA

CARTER  
CRANKCASE

ANIMA® 2,0 150/ 190CC

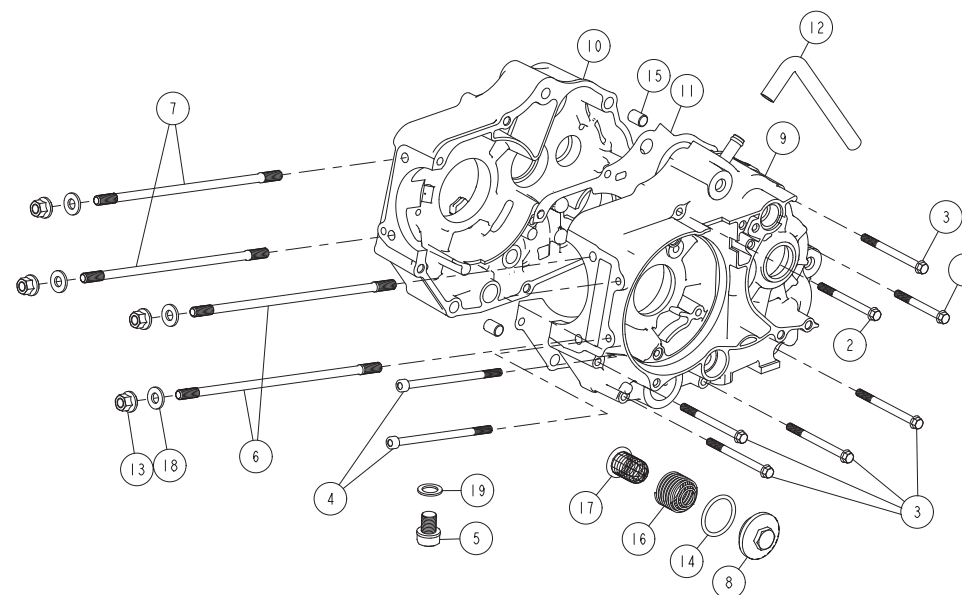

SEQ #	PART #	DESCRIPTION	QTY	(C) UNIT PRICE
1	86448	BOLT, HEXAGON FLANGE M10x16	1	3,00
2	85877	BOLT, HEXAGON FLANGE M6x12	1	1,00
3	86468	BOLT, HEXAGON FLANGE M6x18	6	1,00
4	86466	BOLT, HEXAGON FLANGE M6x25	1	1,00
5	86471	BOLT, HEXAGON FLANGE M6x30	1	1,00
6	83703	BOLT, STUD M6x32	2	2,00
7	86367	COVER, CYLINDER HEAD	1	45,00
8	86366	CYLINDER	1	209,00
9	86436	GASKET, BASE CYLINDER	1	12,00
10	86440	GASKET, HEAD CYLINDER	1	19,00
11	86476	GASKET, M10	1	2,00
12	86405	GASKET, MANIFOLD	1	2,00
13	86439	GASKET, TANSIONER CAM CHAIN	1	1,00
14	86368	HEAD, CYLINDER	1	209,00
15	86404	MANIFOLD, INTAKE	1	19,00
16	86479	O-RING	1	2,00
17	86434	O-RING, COVER HEAD	1	15,00
18	83720	PIN, DOWEL Ø10xØ8,4x14	4	2,00
19	83747	PIN, DOWEL Ø8xØ6,3x12	1	1,00
20	221D021	SPARK PLUG ER9EH	1	39,00
21	86396	TENSIONER, CAM CHAIN COMP	1	25,00
22	86456	WASHER, Ø6,3xØ12x1,5	1	2,00

### CULASSE ANIMA® HEAD CYLINDER

ANIMA® 2,0 150/ 190CC

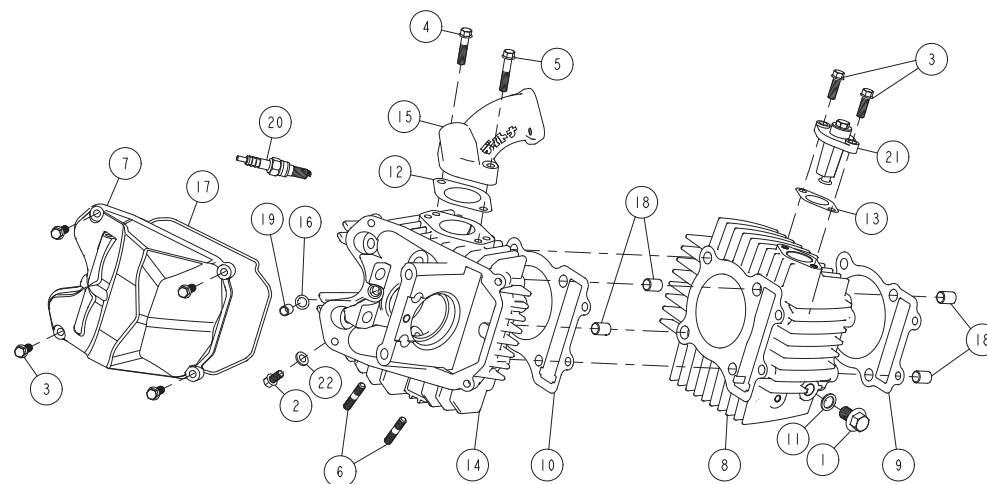

SEQ #	PART #	DESCRIPTION	QTY	(C) UNIT PRICE
1	86481	ARM, ROCKER ROLLER EXHAUST COMP	1	59,00
2	86393	ARM, ROCKER ROLLER INTAKE COMP	1	59,00
3	86460	BOLT, COUNTERSINK M6x15	1	1,00
4	86883	SCREW M6x16	2	1,00
5	86447	BOLT, TENSIONER	1	2,00
6	86878	CAMSHAFT 240Ø ROLLER DECOMP ASM	1	99,00
7	86391	CHAIN, CAMSHAFT DRIVE	1	35,00
8	86402	COTTER, VALVE	8	4,00
9	89681	SHAFT W/WEIGHT,DECOMP,V3	1	49,00
10	86395	GUDE , CHAIN CAMSHAFT	1	20,00
11	86389	PLATE, STOPPER CAM	1	3,00
12	86400	RETAINER, SPRING VALVE	4	5,00
13	86403	SEAL, VALVE STEM Ø4.5	4	6,00
14	86401	SEAT, SPRING VALVE	4	4,00
15	86392	SHAFT, ROCKER	2	5,00
16	87621	SPRING,RETURN DECOMP.	1	2,00
17	86624	SPRING, VALVE	4	16,00
18	86879	SPROCKET, CAMSHAFT DRIVEN	1	15,00
19	87620	PLATE,STOPPER DECOMP.	1	3,00
20	86394	TENSIONER, CAM CHAIN	1	20,00
21	86623	VALVE, EXHAUST Ø21	2	30,00
22	86397	VALVE, INTAKE Ø24.5	2	16,00

### DISTRIBUTION VALVE MECHANISM

ANIMA® 2,0 150/ 190CC

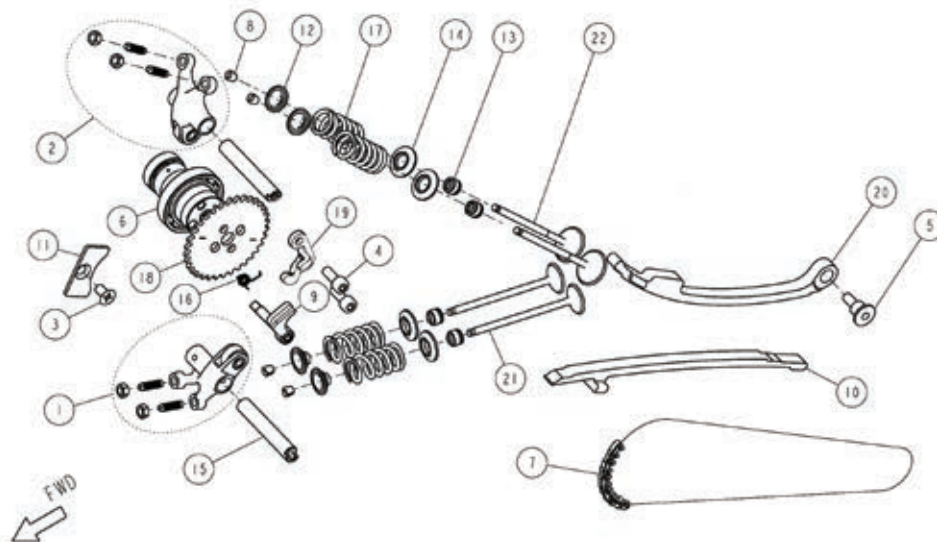

DAYTONA

SEQ #	PART #	DESCRIPTION	QTY	(€) UNIT PRICE
1	83786	BEARING, #6000	1	6,00
2	87619	CLUTCH COMP (FORGED GEAR)	1	179,00
3	86417	GEAR, STARTER DRIVEN 2 13T	1	20,00
4	83768	NUT, SMALL M14	1	3,00
5	83787	PIN, LIFTER CLUTCH	1	20,00
6	86410	WASHER, SPRING Ø24xØ14,2x1,2	1	1,00

DAYTONA

EMBRAYAGE  
CLUTCH

ANIMA® 2,0 150/ 190CC

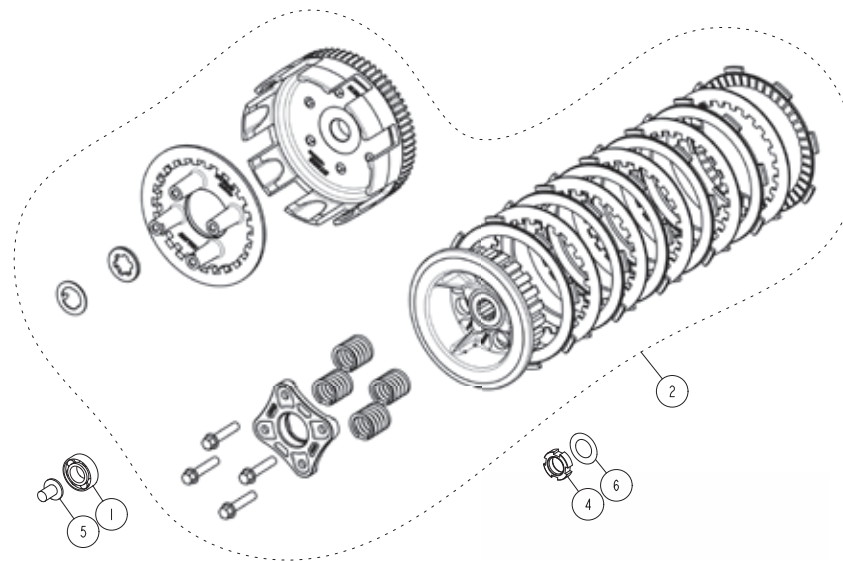

DAYTONA

SEQ #	PART #	DESCRIPTION	QTY	(€) UNIT PRICE
1	83788	BEARING #6001	1	8,00
2	83795	BEARING #6203	2	10,00
3	86454	BEARING NK152712	1	12,00
4	86464	BOLT, HEXAGON SOCKET M6x10	2	1,00
5	86418	GEAR IDLE, STARTER	1	20,00
6	86919	GEAR, COMP,4 SPEED	1	149,00
6	89682	GEAR, COMP 5 SPEED	1	149,00
7	83796	OIL SEAL, Ø29xØ17x5	1	3,00
8	86420	PLATE, FIXING SPROCKET DRIVE	1	2,00
9	86463	RETAINING RING Ø13,6	1	2,00
10	86419	SPROCKET, DRIVE 15T	1	15,00
11	86455	WASHER, Ø22xØ15x0,5	2	1,00

DAYTONA

BOÎTE DE VITESSE  
GEARBOX

ANIMA® 2,0 150/ 190CC

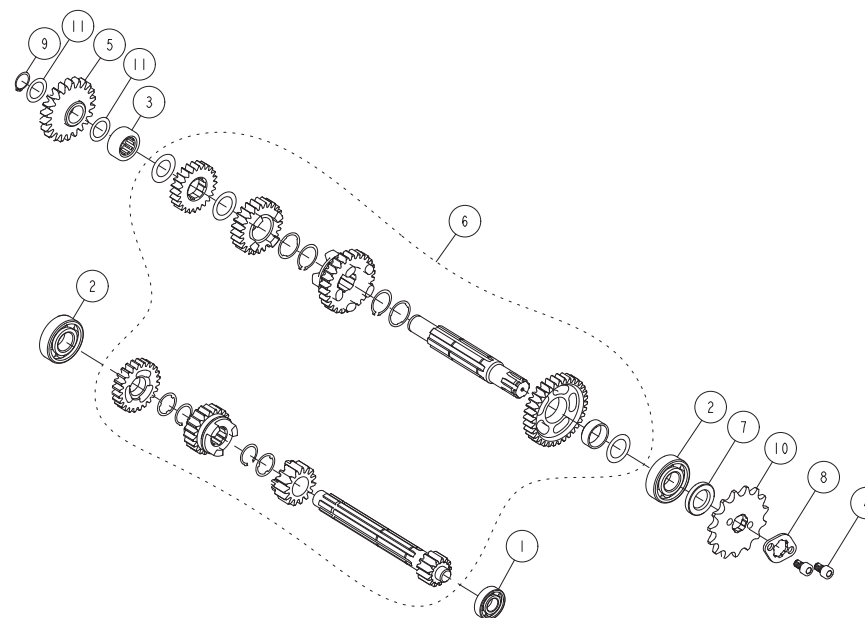



**DAYTONA**

SEQ #	PART #	DESCRIPTION	QTY	(C) UNIT PRICE
1	86449	BOLT, HEXAGON SOCKET M6	1	2,00
2	85877	BOLT, HEXAGON SOCKET M6x15	1	1,00
3	83833	CONTACT, GEAR INDICATION	1	3,00
4	86421	DRUM, SHIFT N-1-2-3-4 COMP	1	55,00
4	88423	DRUM, SHIFT 5 SPEEDS	1	49,00
6	86422	LEVER, GEAR SHIFT COMP	1	20,00
6	88886	LEVER, GEAR SHIFT COMP 5 GEAR	1	20,00
7	86424	LOCATING PLATE UNIT	1	4,00
8	83837	OIL SEAL, Ø24xØ16x10	1	6,00
9	86480	PIN, LOCATING SHIFT LEVER	1	3,00
10	85876	PLATE, LOCATING SWITCH NEUTRAL	1	1,00
11	86423	SPRING, LOCATING PLATE	1	1,00

**DAYTONA**

**BOÎTE/ FOURCHETTES  
GEARBOX MECHANISM**

ANIMA® 2,0 150/ 190CC

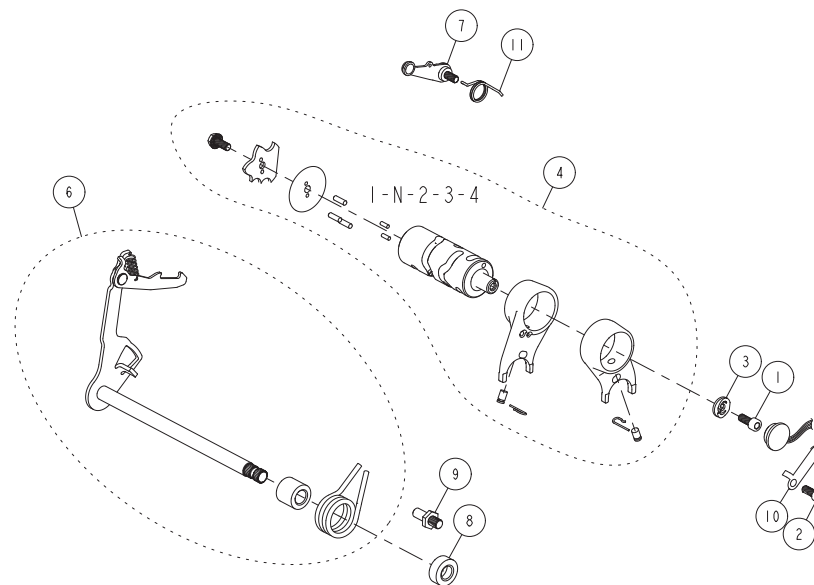

**DAYTONA**

SEQ #	PART #	DESCRIPTION	QTY	(C) UNIT PRICE
1	86407	KICK STARTER ASM	1	89,00
1	88883	KICK ASSY 5 GEAR	1	39,00

**DAYTONA**

**KICK  
KICK STARTER**

ANIMA® 2,0 150/ 190CC

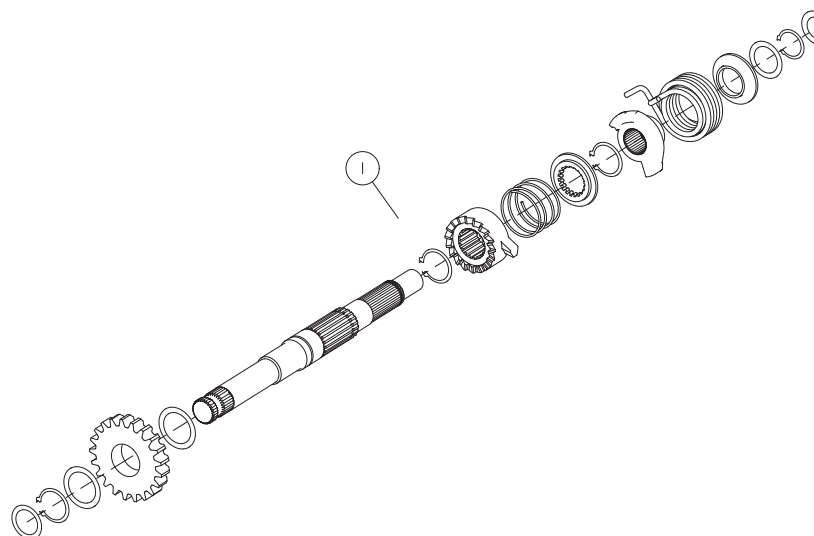

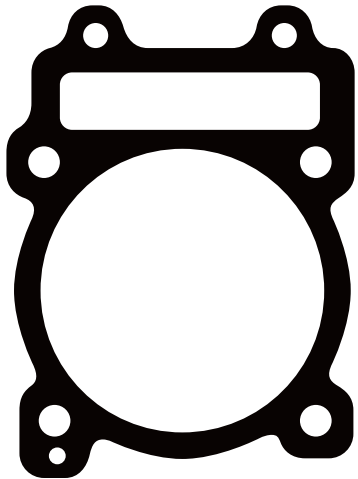

---

**ART DIRECTION**

ENCORE STUDIO

**GRAPHIC DESIGN**

F. ALAUX, T. JUMIN & Q. BRACHET

**INDUSTRIAL DESIGN**

FRANÇOIS ALAUX FOR YCF MOTORCYCLES

**THANKS TO**

#111

STEPHANE LE CORRE, CATHERINE HOSSARD & YCF CREW MEMBERS

MIKE ALESSI, MICHAEL HALL , ALEC PERONNARD, ANDRA ILENE BARNETT

COLIN GALIARDO, ZAKERY GALIARDO, RICKY CARMICHAEL

**TRACK**

OKEFENOKEE, GEORGIA, USA,



[WELCOMETOENCORE.COM](http://WELCOMETOENCORE.COM)

---

**PHOTOGRAPHY**

ACTION & STUDIO: JEFF KARDAS

PARTS: ANTOINE CADOT

**YCF FOUNDERS**

DIMITRI BERA & YANNICK COQUARD





Uw exclusieve YCF dealer:

TOUT LES MODÈLES PRÉSENTÉS SONT DES MOTOS  
AUX NORMES CE. VÉHICULE NON HOMOLOGUÉ  
ET INTERDIT SUR LA VOIE PUBLIQUE. USAGE  
RÉSERVÉ UNIQUEMENT SUR CIRCUIT FERMÉ  
ET PRIVÉ. TOUJOURS PORTER UN CASQUE, DES  
LUNETTES ET DES VÊTEMENTS DE PROTECTIONS.  
NE JAMAIS MONTER EN TANT QUE PASSAGER.

ALL MODELS PRESENTED MEET EC STANDARDS.  
VEHICLE NOT AUTHORIZED ON THE PUBLIC ROAD WAYS.  
RESERVED ONLY ON CLOSED AND PRIVATE TRACKS.  
ALWAYS WEAR HELMET, GOGGLE AND ADAPTED  
PROTECTIONS. NEVER RIDE WITH A PASSENGER.

FOLLOW  
US!



YCF SE RÉSERVE LE DROIT DE MODIFIER LES  
CARACTÉRISTIQUES ET LES PRIX DE SES PRODUITS.  
TOUTE REPRODUCTION MÊME PARTIELLE DE CE  
CATALOGUE DOIT FAIRE L'OBJET D'UN ACCORD  
PRÉALABLE AVEC YCF.

YCF RESERVES THE RIGHT TO MODIFY THE  
SPECIFICATIONS OR THE PRICES OF ITS PRODUCTS. ANY  
REPRODUCTION IN WHOLE OR IN PART OF THIS  
CATALOGUE REQUIRES THE PRIOR AGREEMENT OF YCF.

### Uw YCF Importeur:

YCF Nederland  
Griekenlandlaan 40  
9403 DZ Assen  
Telefoon+31 (0) 615-301-333  
[www.ycfnederland.nl](http://www.ycfnederland.nl)